



Tangga Mas Jaya Makmur PT.
 SCAFFOLDING MANUFACTURER
WWW.SCAFFOLDINGTM.COM



BEKISTING SYSTEM



MAIN FRAME SYSTEM



KWIKSTAGE SYSTEM

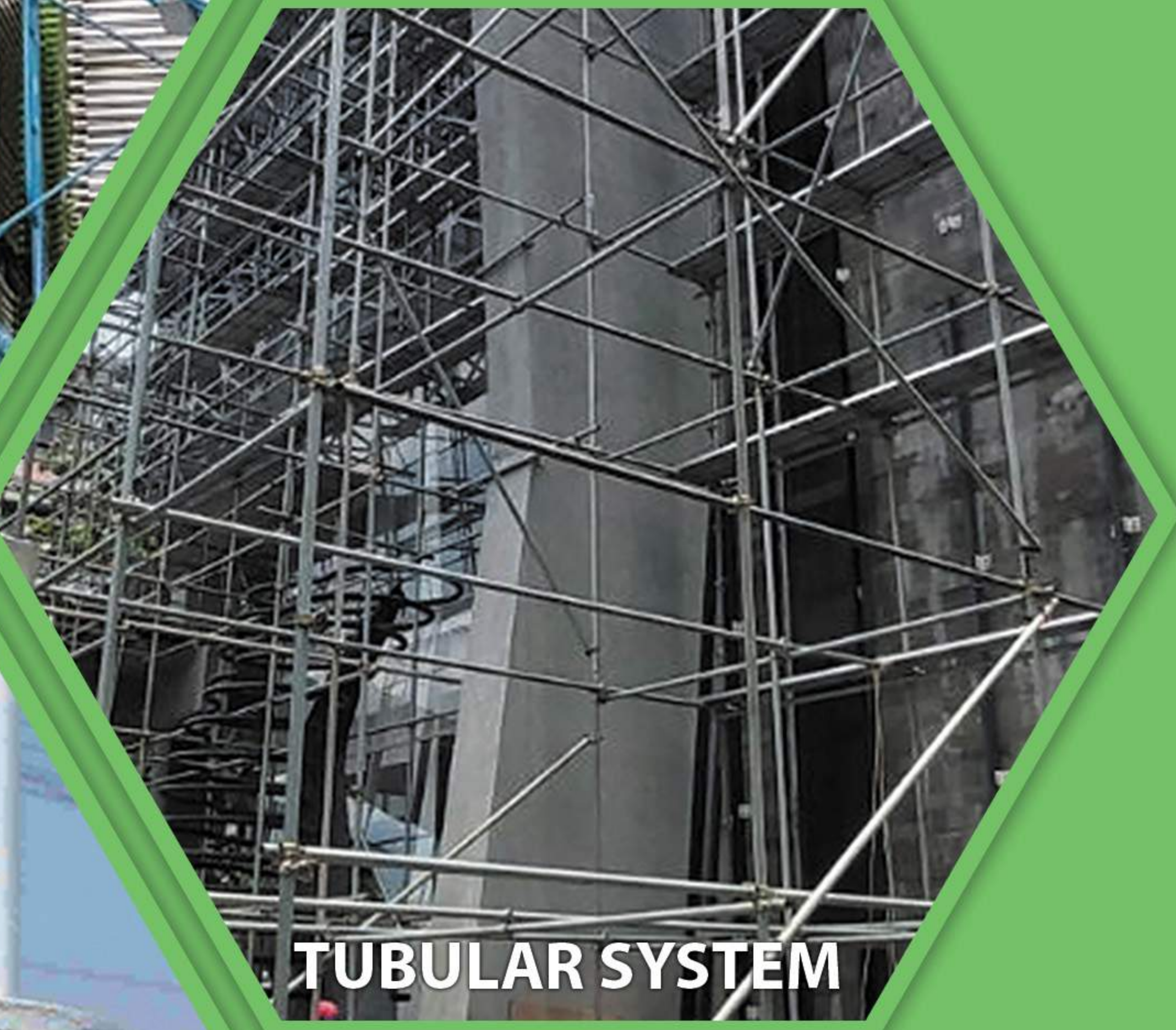

TUBULAR SYSTEM



RINGLOCK SYSTEM

No.1 Scaffolding Manufacturer



Kementerian Perindustrian
 REPUBLIK INDONESIA



MAIN FRAME SYSTEM AVAILABLE COLOR   

Download
Tanggamas
Online



 Tanggamas Online

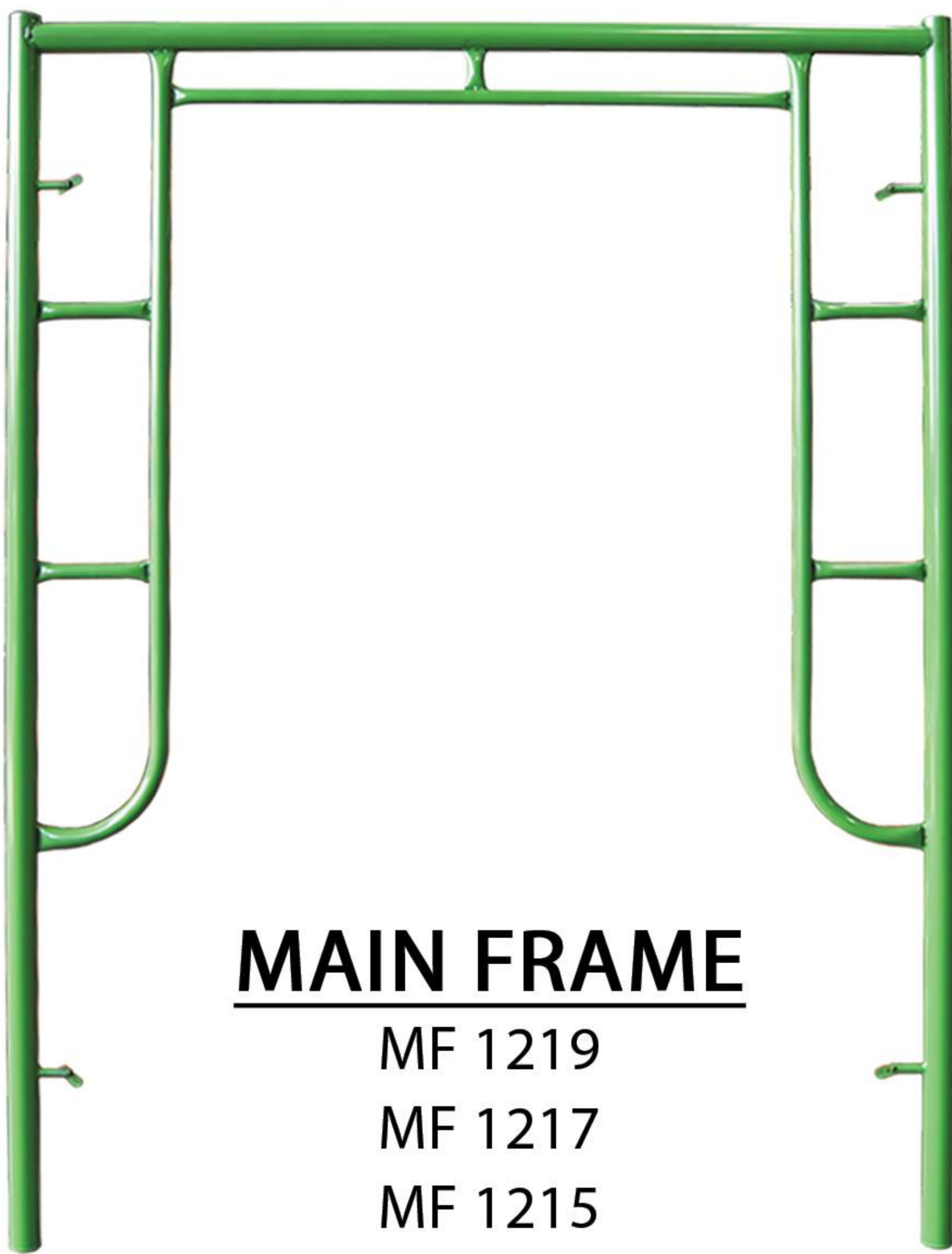

MAIN FRAME

- MF 1219
- MF 1217
- MF 1215



CROSS BRACE

- CB 220
- CB 210
- CB 193
- CB 185



STAIR

- ST 219
- ST 217

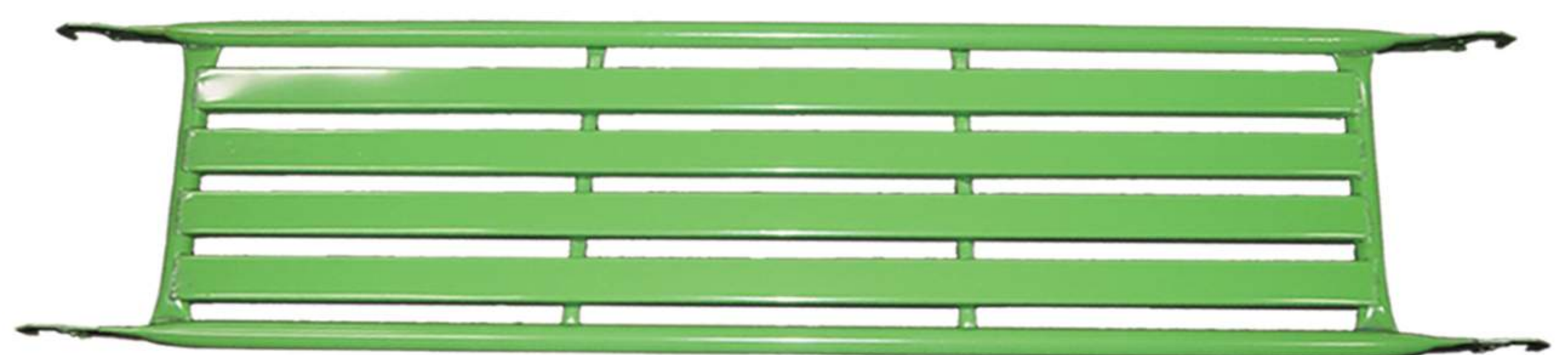

CATWALK

CW A1850



CATWALK BORDES

CW A1850



JOIN PIN

JP A 20



U HEAD T-60



JACKBASE T-60



LADDER FRAME

- LF 1212
- LF 1209
- LF 1205

●●● AVAILABLE COLOR **MAIN FRAME SYSTEM**



TM. Tanggamas Online



Download
Tanggamas
Online



PIPE SUPPORT

- TS 90
- TS 70
- TS 60
- TS 50,



**CASTER WHEEL
NYLON**

- 8 INCH
- 6 INCH

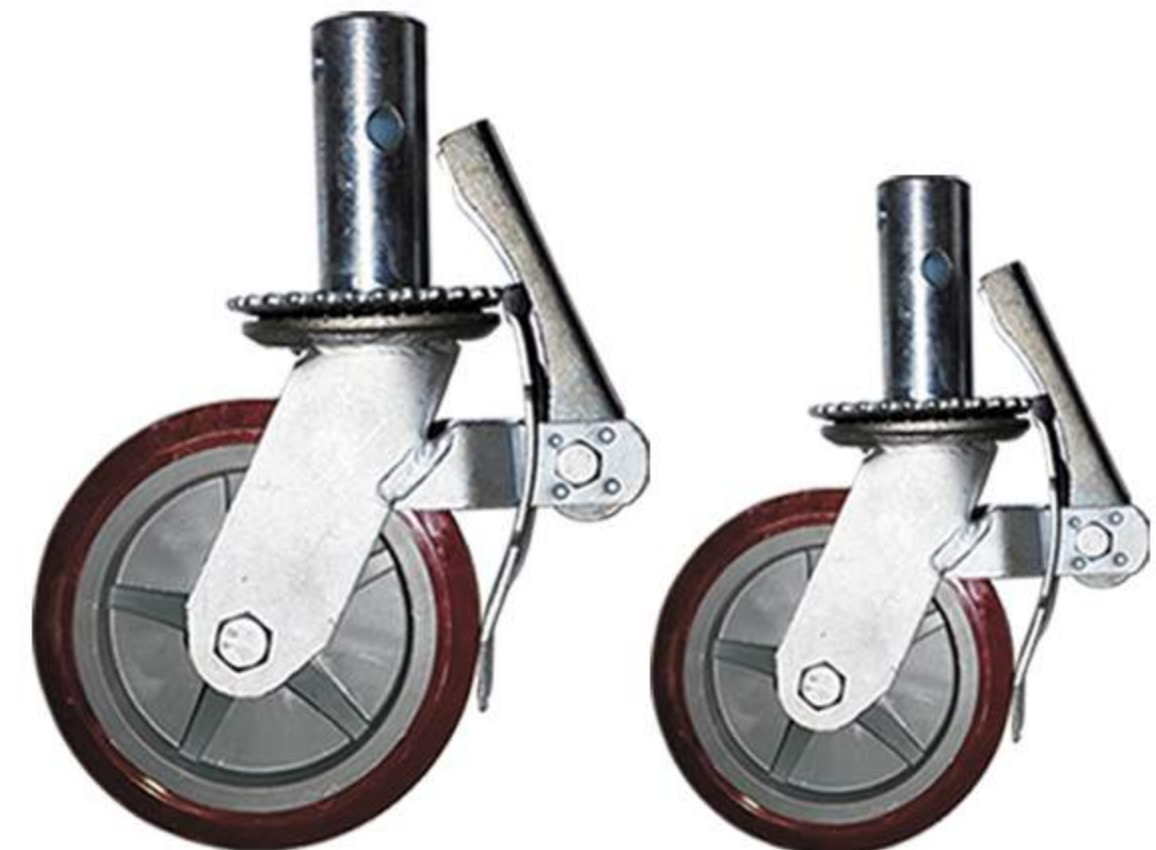

**CASTER WHEEL
POLYURETHANE**

- 8 INCH
- 6 INCH

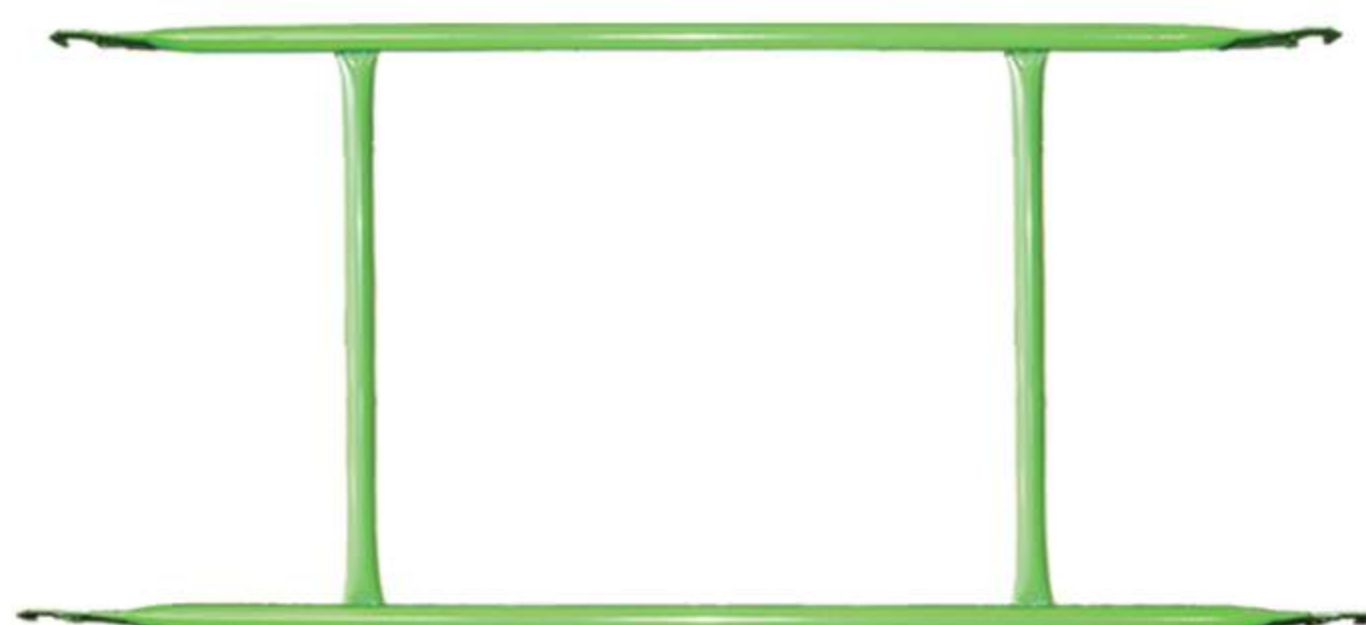

HORIZONTAL FRAME

HF 170

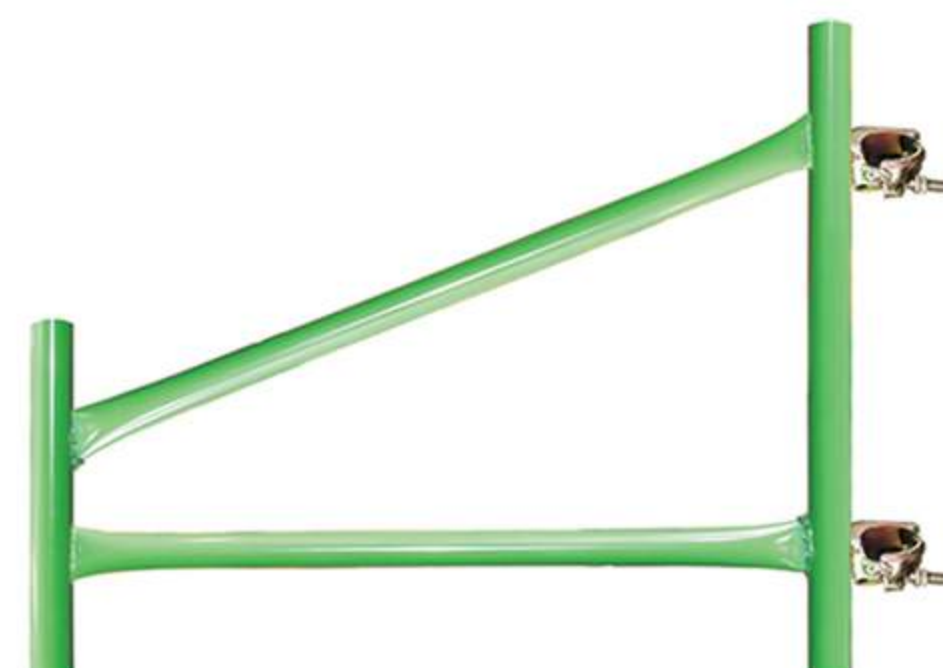

CANTILEVER

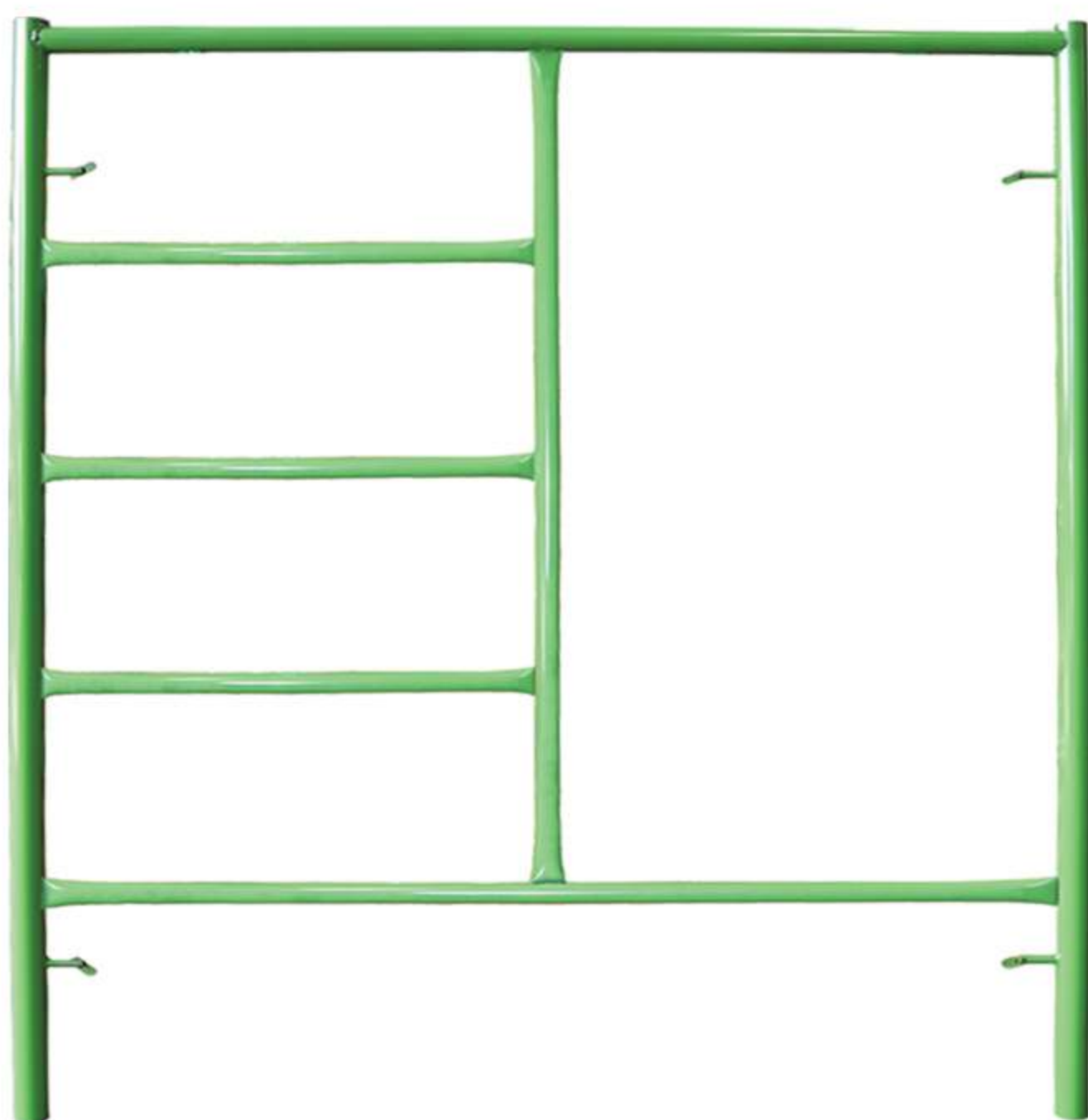
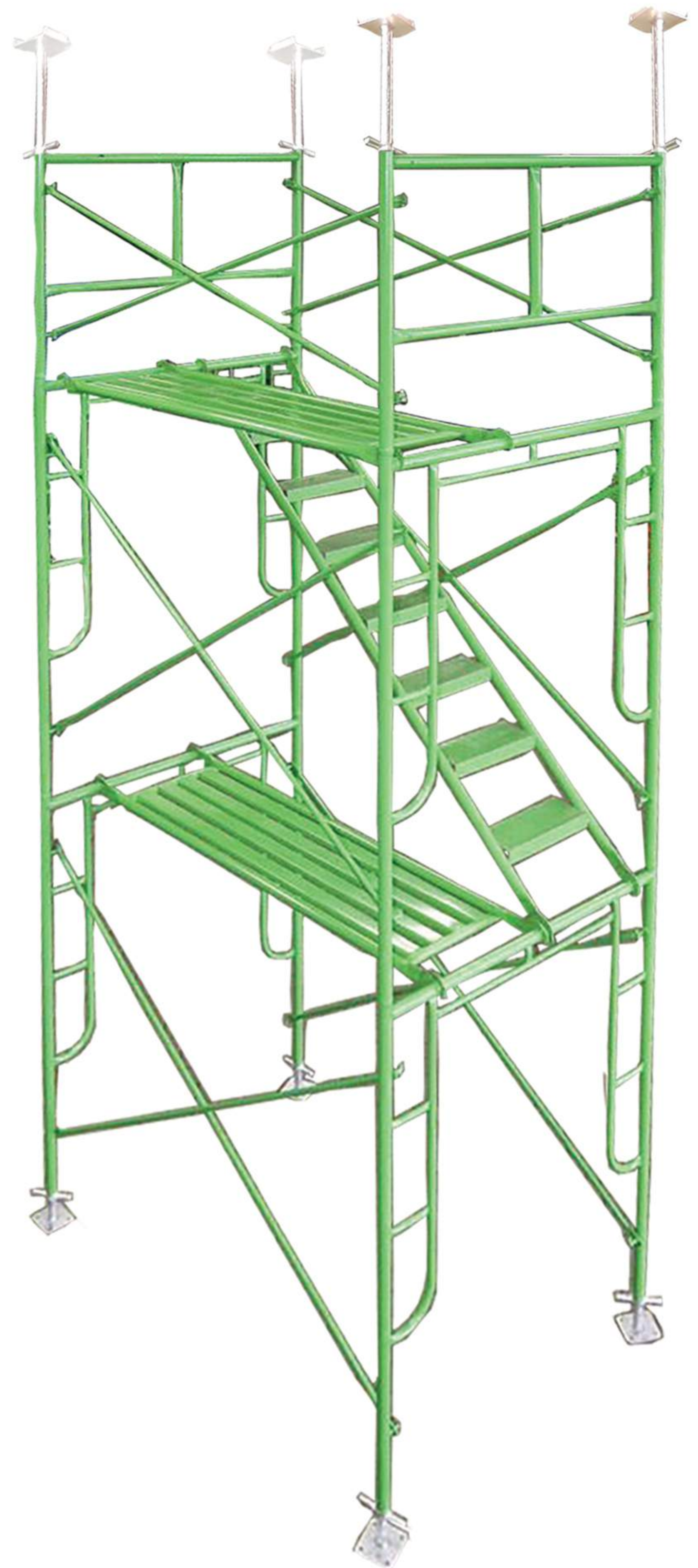

**MAINFRAME ROLLING
TOWER**

MRT 170

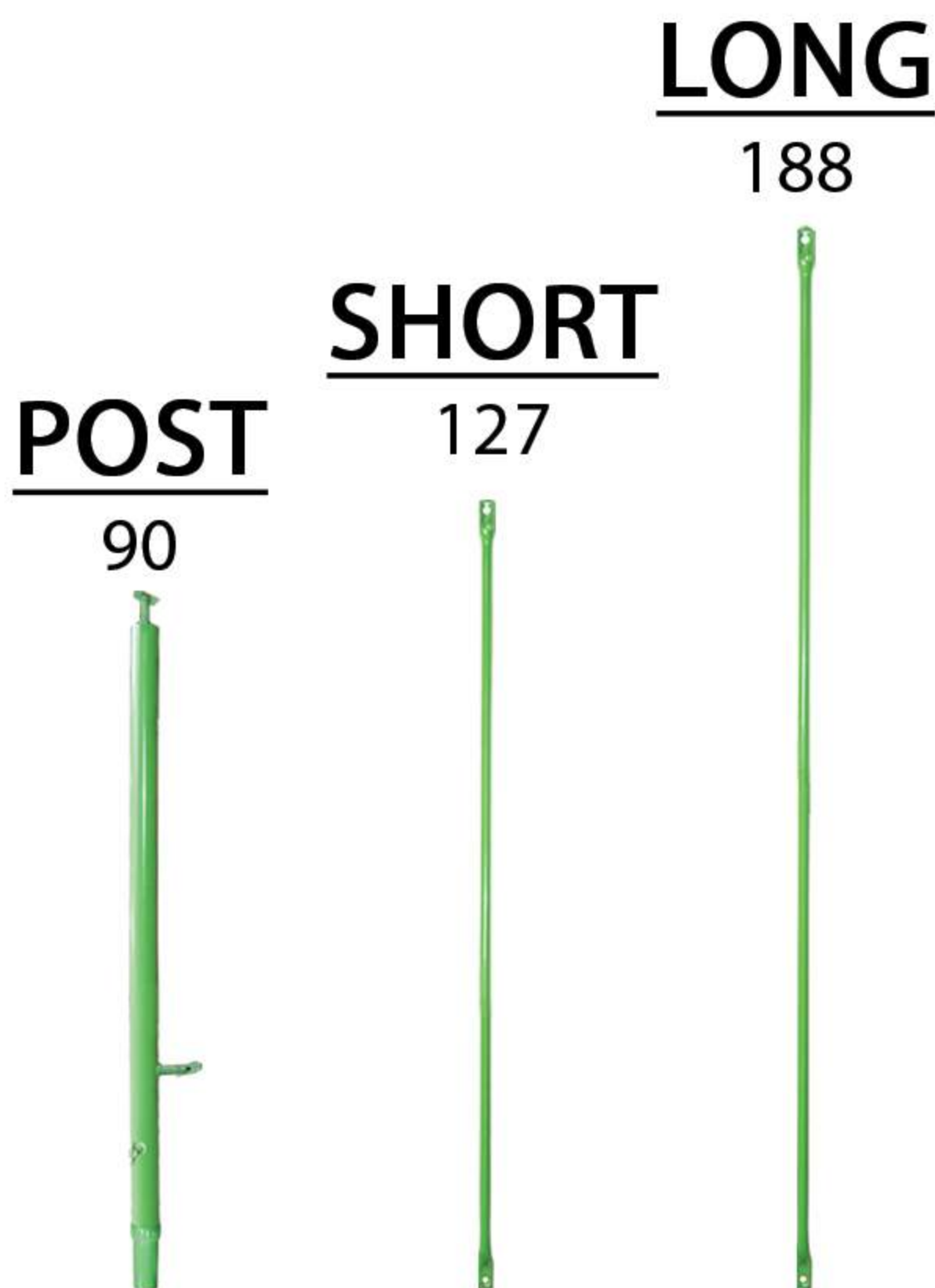

POST
90

SHORT
127

LONG
188

GUARDRAIL



scaffoldingtm.com



MAIN FRAME SYSTEM GALVANIZED

Download
Tanggamas
Online



Tanggamas Online



SCAFFOLDING T-170

- MF 1219
- MF 1217
- MF 1215



CROSS BRACE

- CB 220
- CB 210
- CB 193
- CB 185



STAIR

- ST 219
- ST 217



PIPE SUPPORT

- TS 90
- TS 70
- TS 60
- TS 50

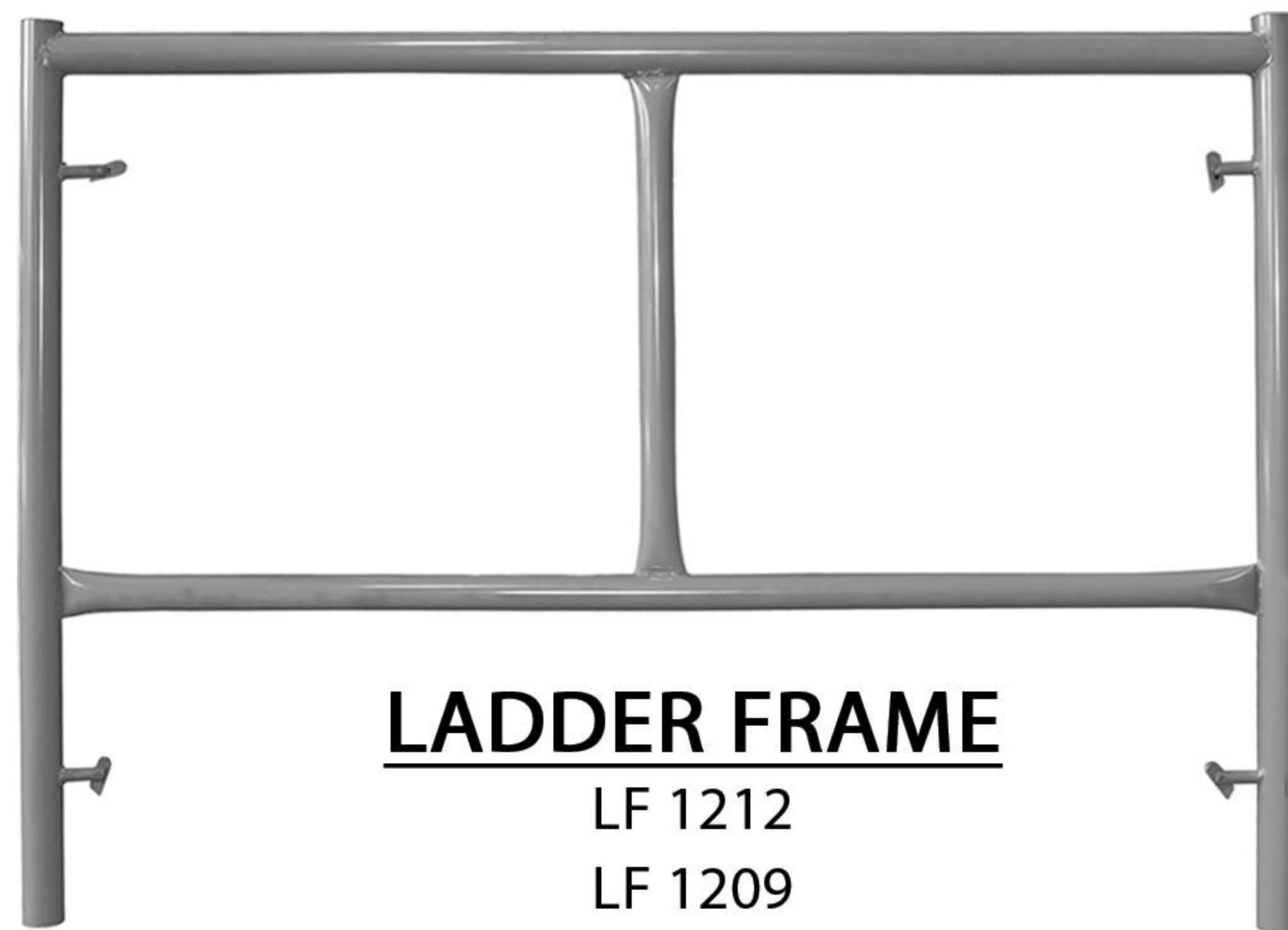

LADDER FRAME

- LF 1212
- LF 1209
- LF 1205



JOIN PIN

- JP A20

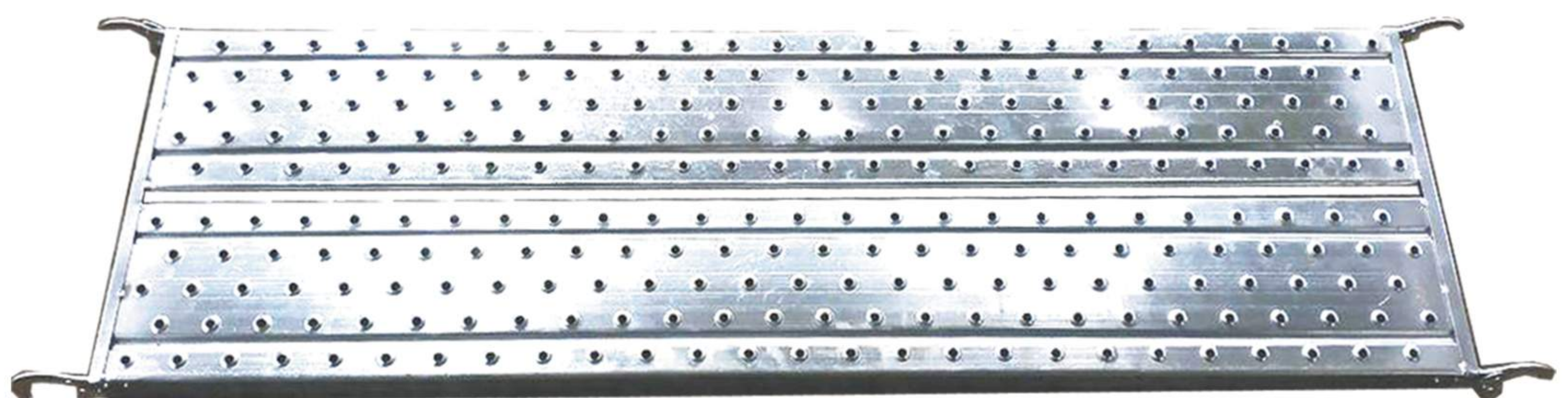

CATWALK

- A 1850



HOT DIP GALVANIZED PIPE

1,5" 6M 2,4mm
1,5" 6M 3,2mm
1,5" 6M 4mm



GALVANIZED METAL PLANK

1M, 2M
3M, 4M



FIX / SWIVEL CLAMP



ENGLAND FIX / SWIVEL
PRESSED STEEL BS



DROP FORGED
FIX / SWIVEL COUPLER



FIX / SWIVEL
BEAM CLAMP



GIRDER FIX / SWIVEL
DROP FORGED COUPLER



FIX / SWIVEL
48 / 60 JIS



LIMPET
COUPLER BS



SLEEVE COUPLER



INNER JOINT
PIN BS



INNER JOINT
PIN JIS



TUBULAR SYSTEM

Download
Tanggamas
Online



TM. Tanggamas Online



PUTLOG COUPLER

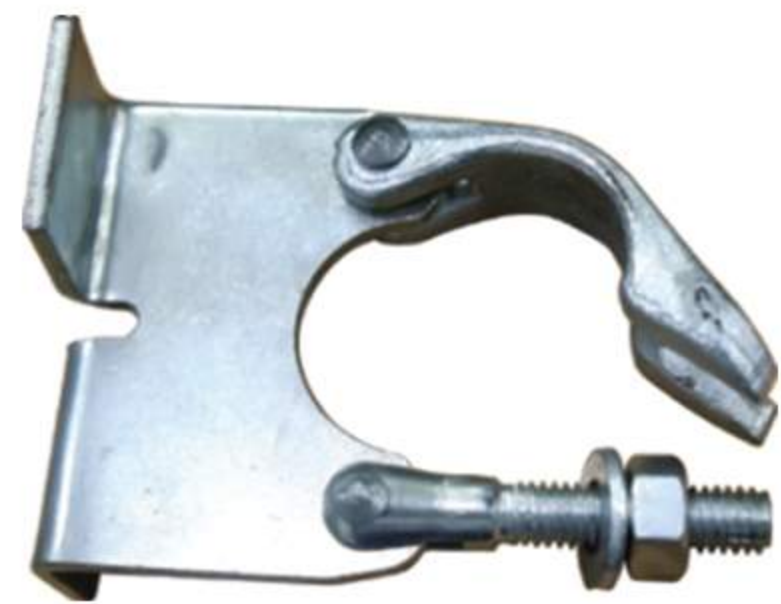

BOARD RETAINING
COUPLER



BASE PLATE
150x150MM



LADDER CLAMP



RATCHET 17/21



SCAFFOLDING TAG



PIPE END CAP



CLAMP COVER
BS



CLAMP COVER
JIS



CASTER POLY
MIDDLE 8"



JACKBASE T60



U-HEAD T60



ALUMINIUM LADDER

3M; 4M; 5M; 6M



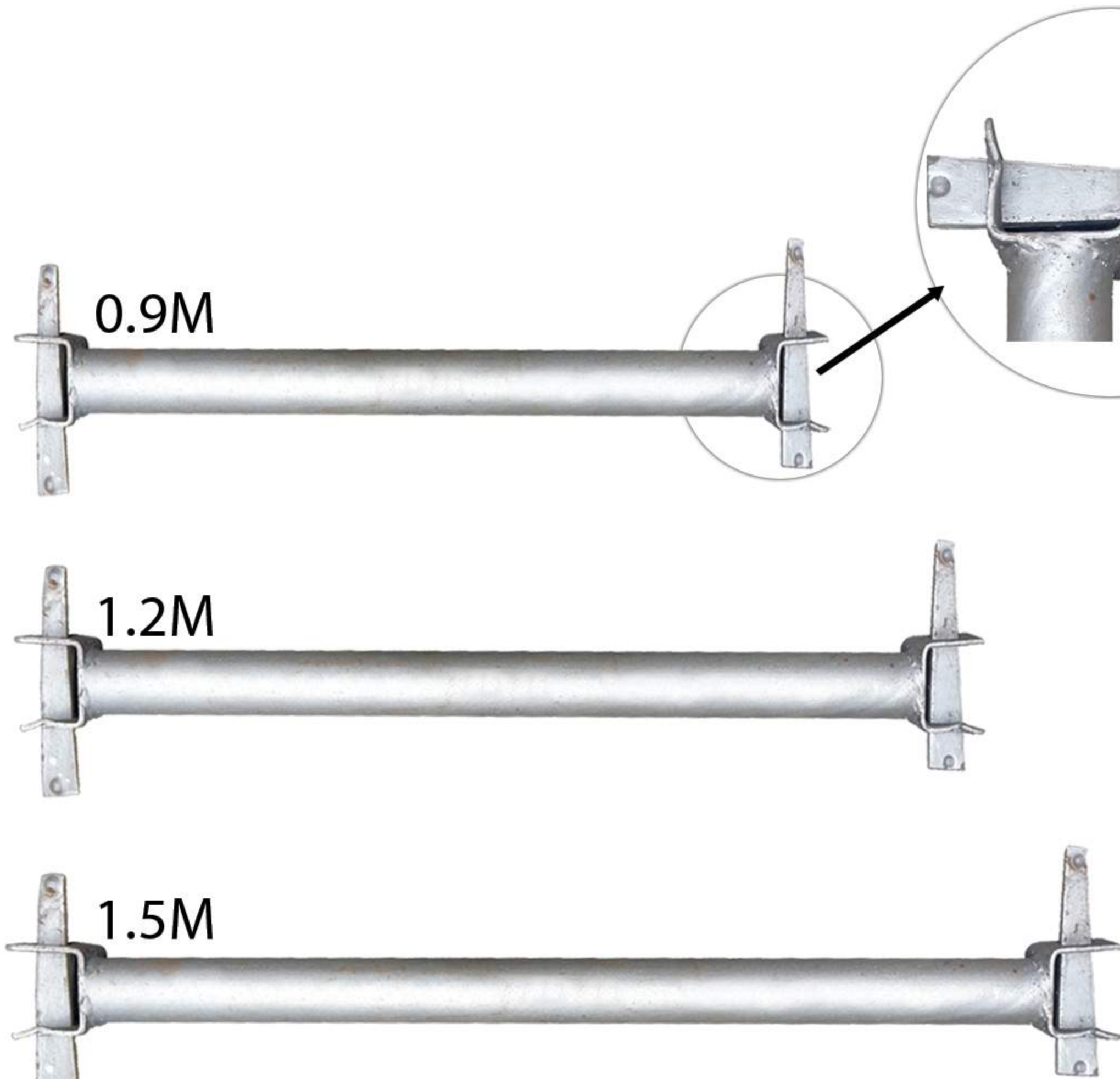

LEDGER



KWIKSTAGE STANDARD

0.5M, 1M, 1.5M, 2M, 2.5M



JACK BASE



U-HEAD



V-CLIP

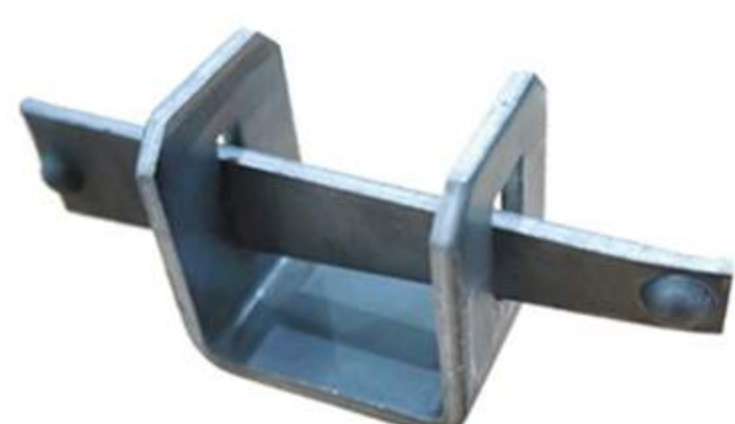

CLAW SET





RINGLOCK SYSTEM

Download
Tanggamas
Online



T.M. Tanggamas Online

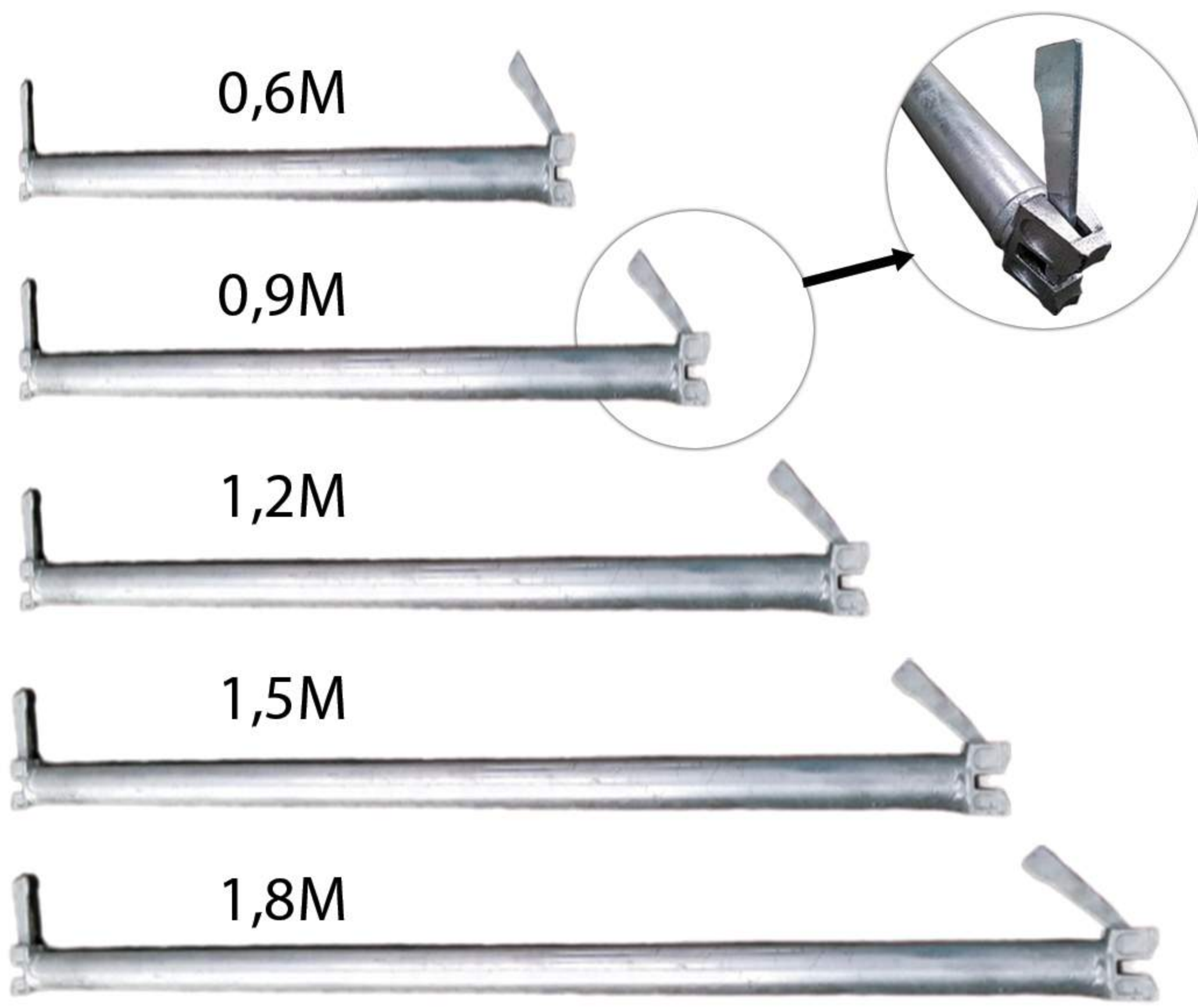

RINGLOCK LEDGER



RINGLOCK CATWALK

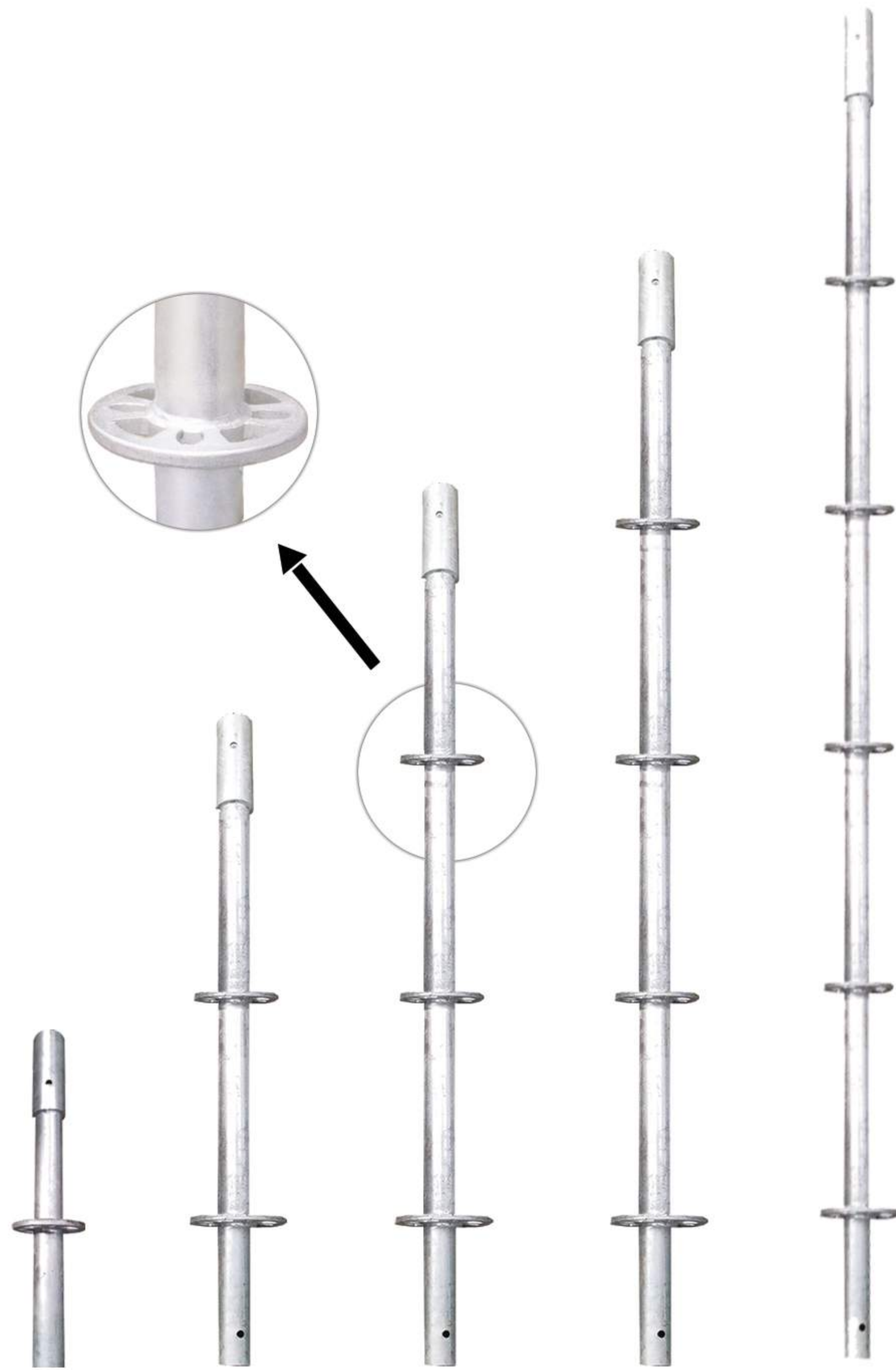

RINGLOCK STANDARD

0,5M 1M 1,5M 2M 2,5M



RINGLOCK STAIR

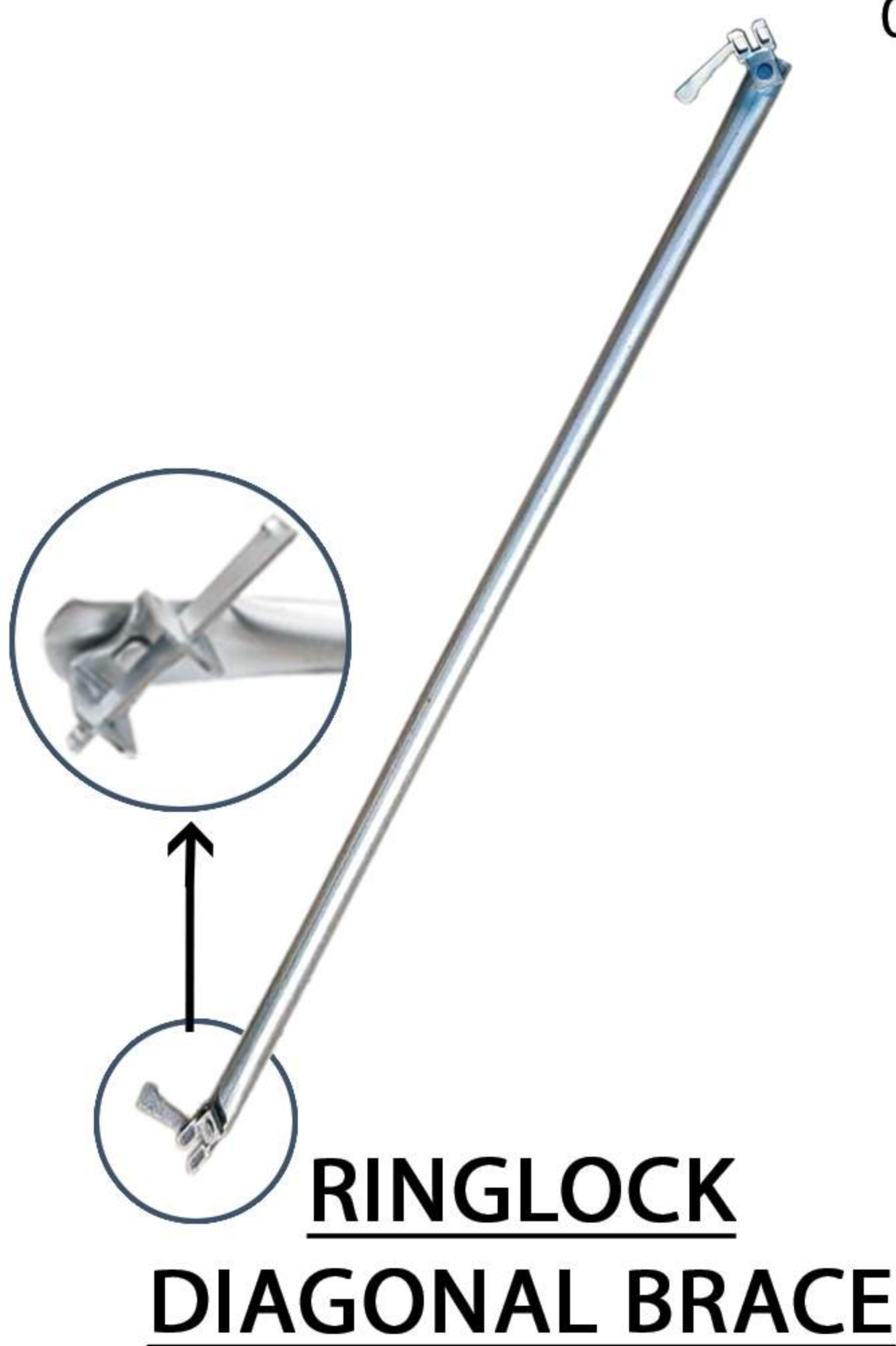

**RINGLOCK
DIAGONAL BRACE**



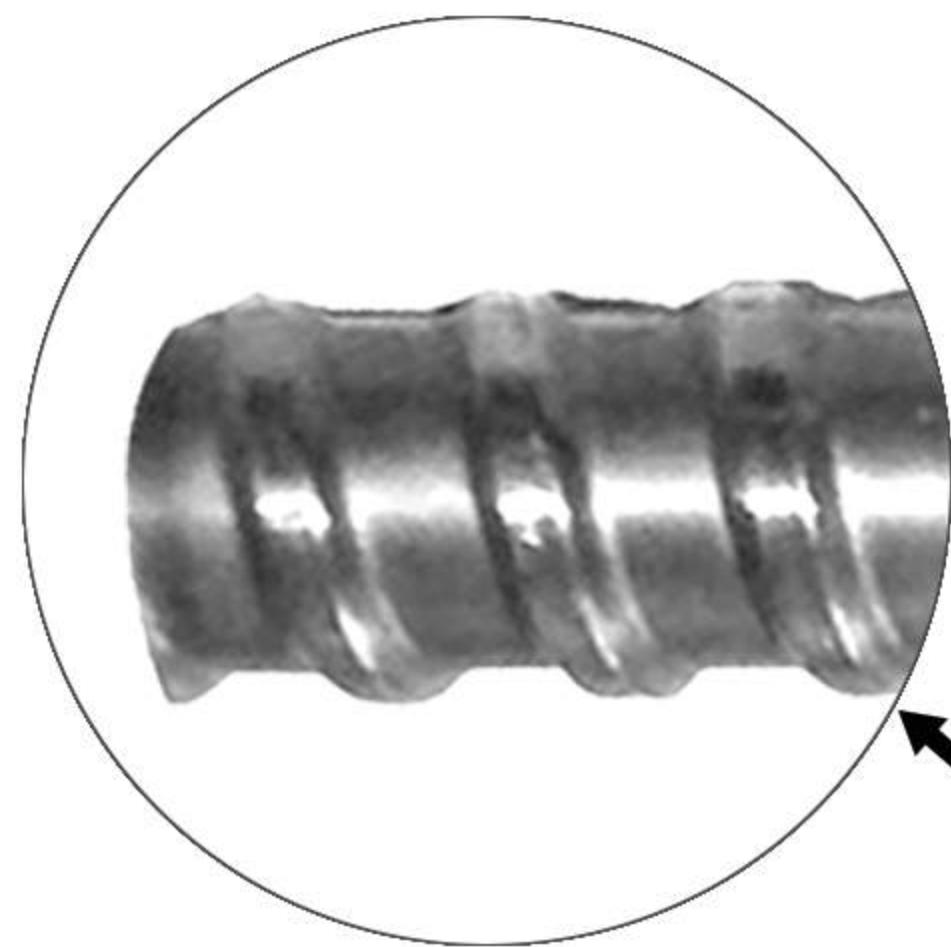

TIE ROD - M 16
1M, 2M, 3M, 4M, 5M, 6M



WINGNUT



TIE NUT



WATERSTOPPER



STEEL CONE



SPRING CLIP



TENSIONER

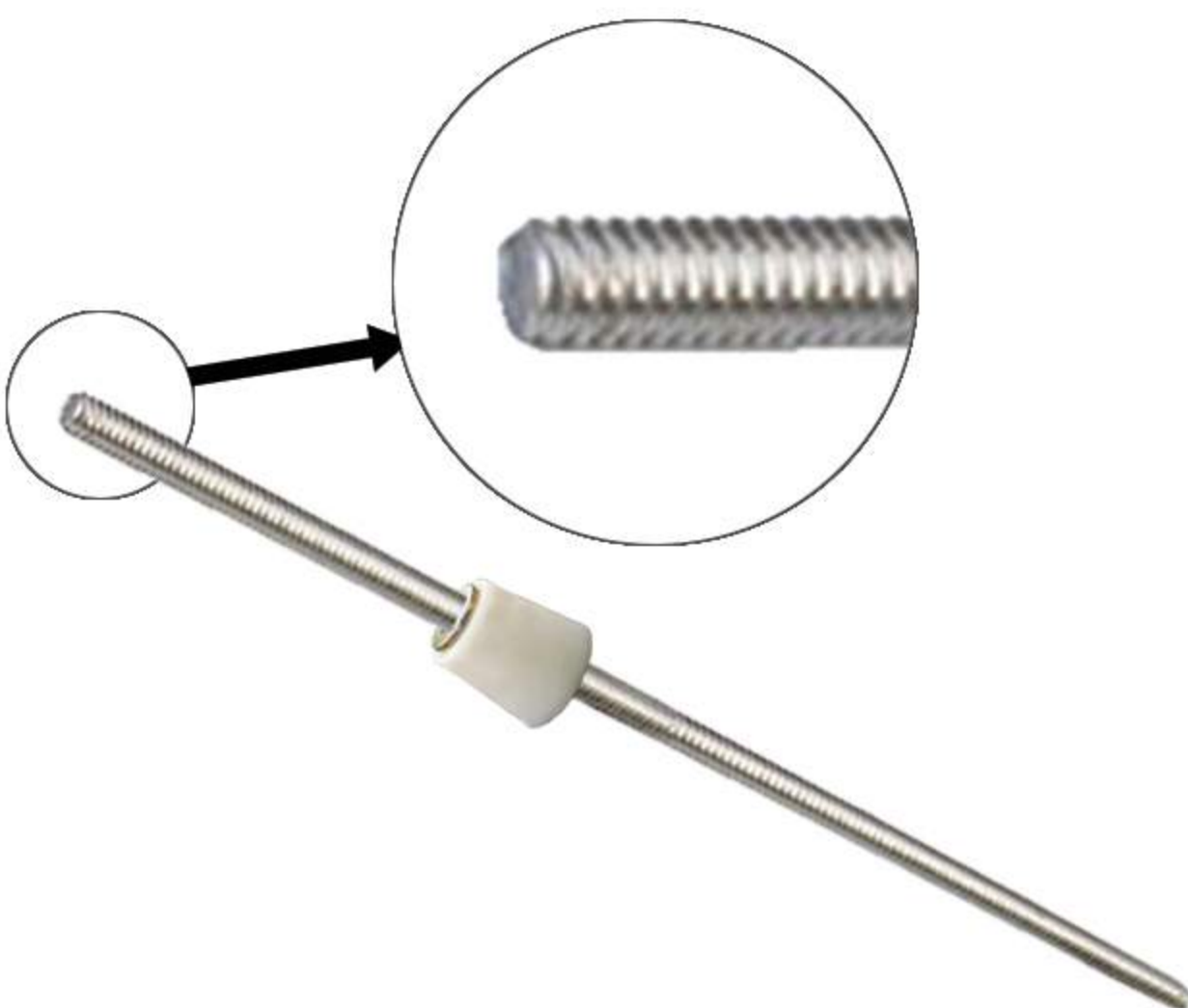

FORM TIE M12

1M



PLASTIC CONE



WASHER



BEKISTING SYSTEM

Download
Tanggamas
Online



Tanggamas Online

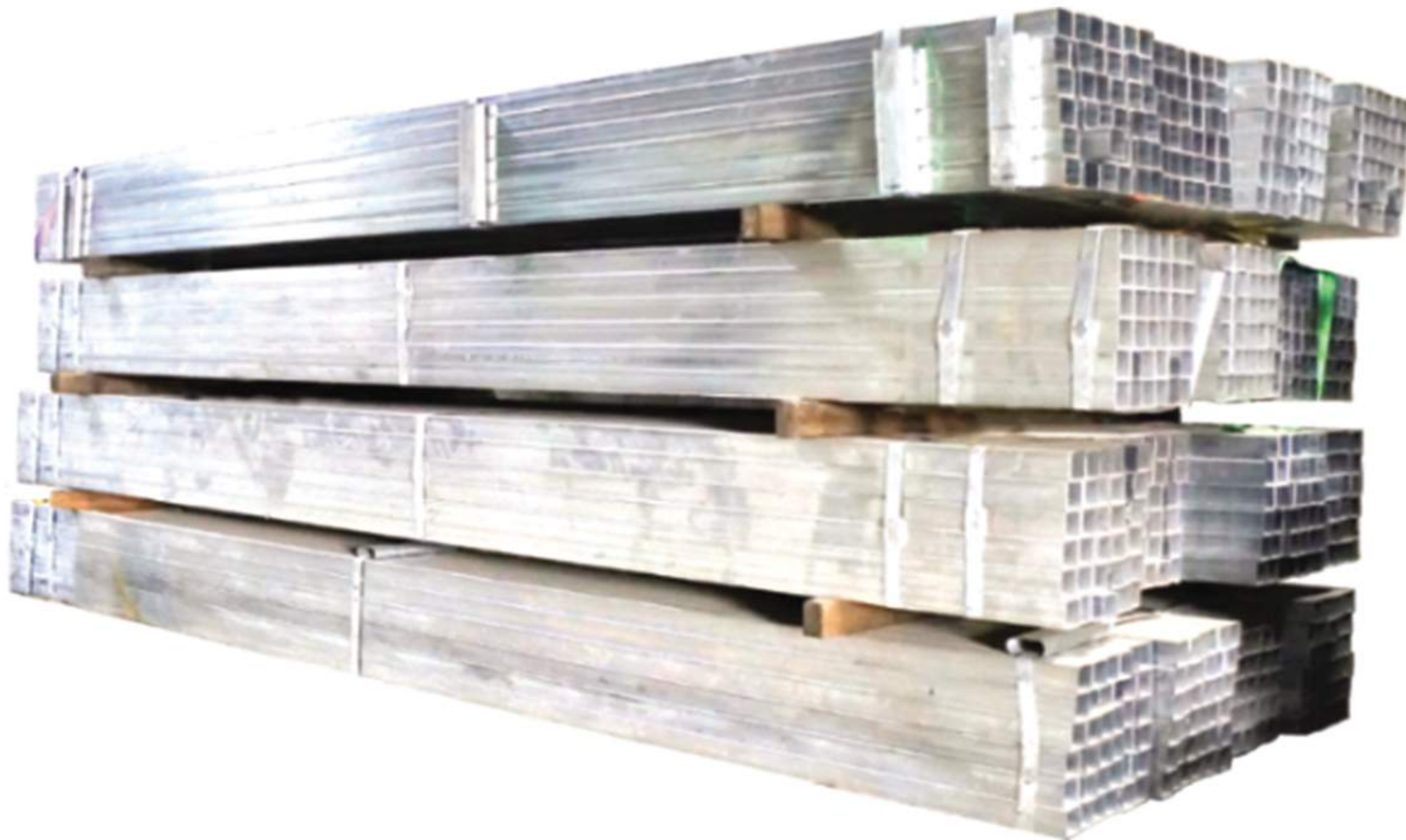

GALVANIZED HOLLOW

50 x 50 x 2MM - 4M

50 x 50 x 2MM - 6M

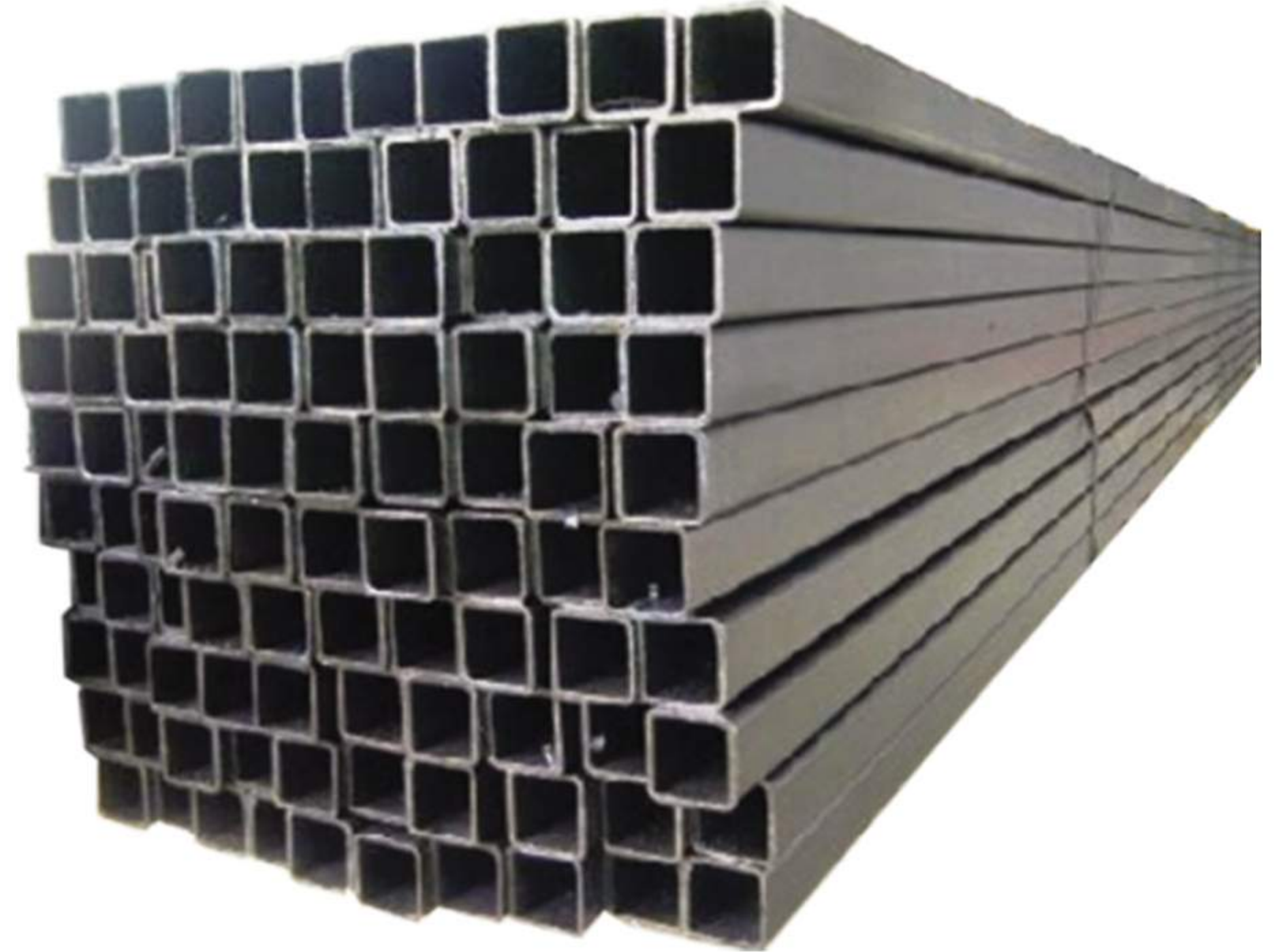

BLACK HOLLOW

50 x 50 x 2MM - 6M



PUSH PULL PROP

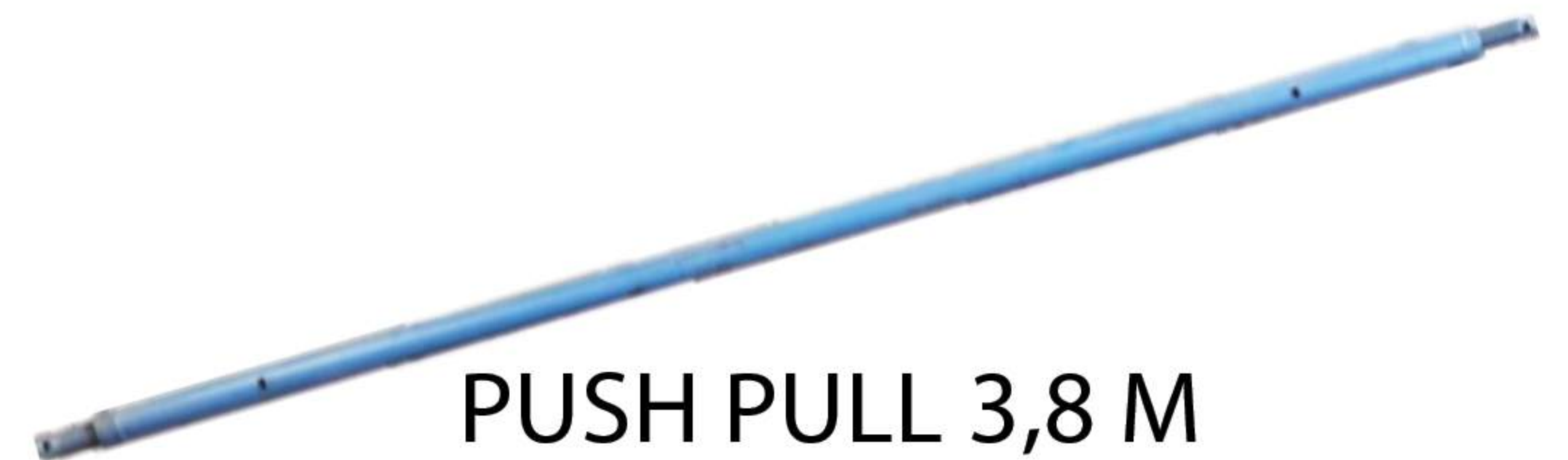

PUSH PULL 3,8 M



PUSH PULL 2,94 M



AV KICKER



BASE PLATE

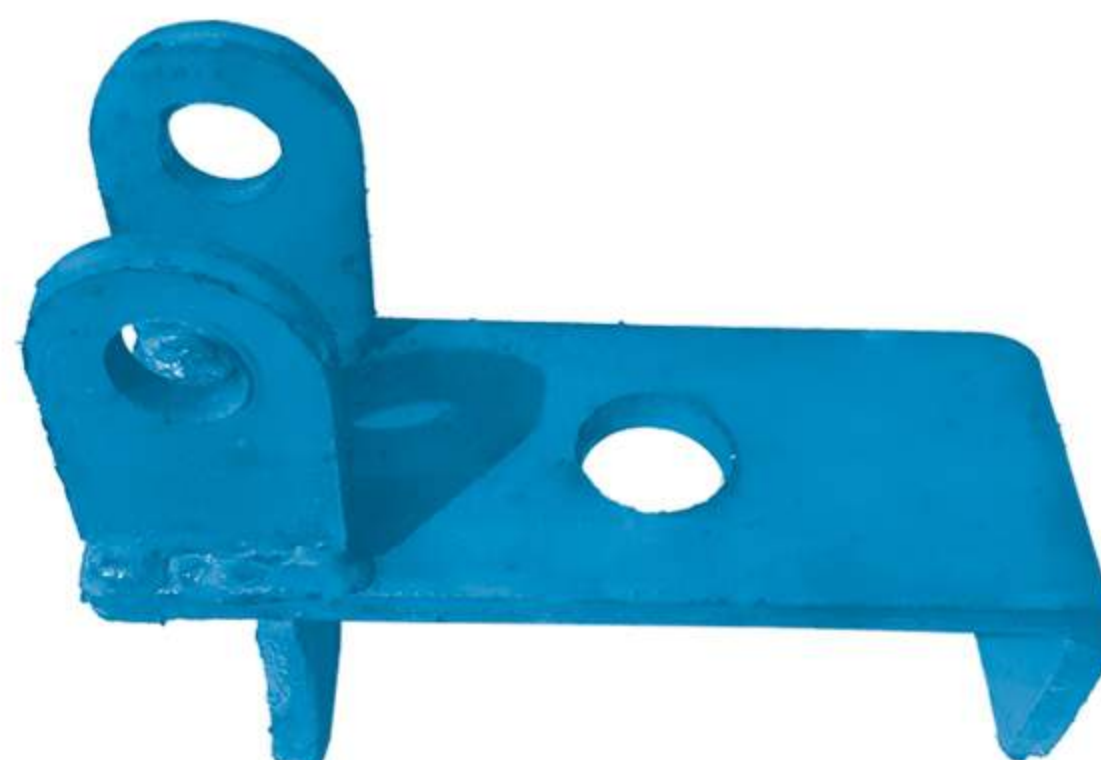

WAP



MURR & BOLT



UNP (KOLAM / GLAGAR / ENKELAN)

- 80x45x3MM - 2M
- 80x45x3MM - 3M
- 80x45x3MM - 4M
- 80x45x3MM - 6M

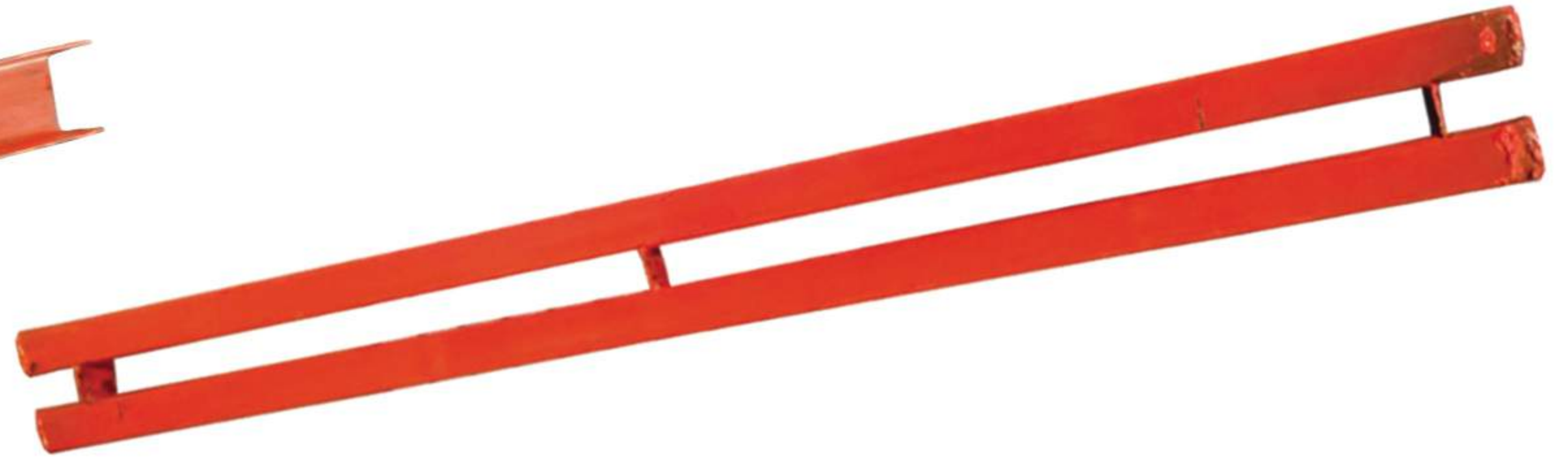

SURI SURI SABUK KOLOM

- 0,75M
- 1,2M
- 1,5M



HOLLOW

- 50x50x2MM - 1M
- 50x50x2MM - 2M
- 50x50x2MM - 3M
- 50x50x2MM - 6M



SURI - SURI / BEAM RILL

- 1,5M
- 2 M



BRACING SIKU FOR BEAM

- 40x40x4MM - 1,2M
- 40x40x4MM - 2,4M



BEKISTING CLIMBING



KAWEL

- 350MM
- 500MM

BEAM CLAMP 40x40x4MM



ANGLE BEAM



TIPE A

28 x 21 x 23



TIPE B

48 x 38 x 45



TIPE C

62 x 58 x 73



TM[®]
Tangga Mas
SCAFFOLDING BERKUALITAS

Get in touch



Jl Bangkingan No. 16
Surabaya - Jawa Timur



tanggamasyajamakmur@yahoo.com



031 753 2760



0812 3188 8989



Tangga Mas Jaya Makmur



PT. Tangga Mas Jaya Makmur



scaffoldingtanggamas



Tangga Mas Jaya Makmur

Get in on



SCAN HERE
For DOWNLOAD
CATALOG

