



**Downlight SK-D01**

Downlight & Spot  
Lighting

## Downlight *Horizontal*



SK - 7300



SK - 7400



SK - 7600

### Product Specification

Type	: SK-7300 , SK-7400 , SK-7600
Lamp	: PLC 10,13,18 W / Essential 11,14,18 W
Housing	: Mild Steel
Finishing Procces	: Powder Coating
Reflector	: Anodized Aluminium Mirror
Ingress Protection	: IP 20
Can Use Battery for PLC	

### Dimension (mm)

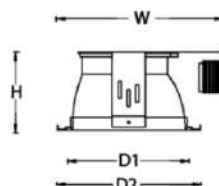

Type	D1	D2	W	H
SK - 7300	95	116	150	60
SK - 7400	115	140	165	80
SK - 7600	145	172	200	95

### Equipment

Type	Recommended Lamp	Lamp Holder	Ballast
SK - 7300	PLC 10 W	G24d	Magnetic Ballast
	Essential 11 W	E27	-
SK - 7400	PLC 13 - 18 W	G24d	Magnetic Ballast
	Essential 14 - 18 W	E27	-
SK - 7600	PLC 18 W	G24d	Magnetic Ballast
	Essential 18 W	E27	-

## Downlight *Vertical*



DL 2ft / Adj



DL 3ft

### Product Specification

Type	: DL 2ft/Adj , DL 3ft
Lamp	: Bulb, PLC, ESSENTIAL
Housing	: Mild Steel
Finishing Procces	: Powder Coating
Reflector	: Anodized Aluminium Mirror
Ingress Protection	: IP 20
Can Use Battery for PLC	
Can Use LED Bulb	

### Equipment

Type	Recommended Lamp	Lamp Holder	Ballast
DL 2ft / Adj - 401 , DL 3ft (Dia. 4")	PLC 10 W	G24d	Magnetic Ballast
	Essential 8 W	E27	-
DL 2ft / Adj - 501 , DL 3ft (Dia.5")	PLC 13 W	G24d	Magnetic Ballast
	Essential 11 - 14 W	E27	-
DL 2ft / Adj - 601 , DL 3ft (Dia. 6")	PLC 18 w	G24d	Magnetic Ballast
	Essential 14 - 18 W	E27	-

### Dimension (mm)

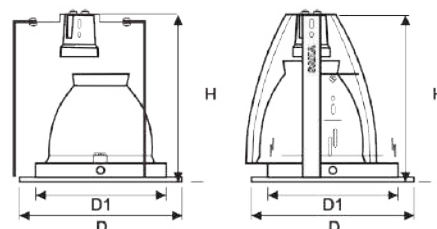

Type	D1	D2	H
DL 2ft / Adj - 401 , DL 3ft (Dia 4")	119	145	170 / Adjustable
DL 2ft / Adj - 501 , DL 3ft (Dia 5")	130	158	184 / Adjustable
DL 2ft / Adj - 601 , DL 3ft (Dia 6")	145	173	184 / Adjustable

# LED Downlight *SK-D01*



## Product Specification

Input Voltage	: 100-240V/220-240V 50/60H
CRI	: >80 Ra
Beam Angle	: 120°
Dimming	: No
Operator Temp.	: -20°C-50°C
Ingress Protection	: IP 44

Model	Power	Lumen	CCT	Dimension (mm)	Cut Hole
SK-D401-M08W	8W	1050 lm	30K/40K/50K/60K	D140*H80	φ120mm
SK-D401-M10W	10W	1560 lm	30K/40K/50K/60K	D140*H80	φ120mm
SK-D401-M12W	12W	1560 lm	30K/40K/50K/60K	D140*H80	φ120mm
SK-D501-M12W	12W	1560 lm	30K/40K/50K/60K	D180*H80	φ150mm
SK-D501-M15W	15W	1950 lm	30K/40K/50K/60K	D180*H80	φ150mm
SK-D601-M15W	15W	1950 lm	30K/40K/50K/60K	D190*H80	φ170mm
SK-D601-M20W	20W	2600 lm	30K/40K/50K/60K	D190*H80	φ170mm
SK-D801-M25W	25W	3250 lm	30K/40K/50K/60K	D230*H88	φ200mm
SK-D801-M30W	30W	3900 lm	30K/40K/50K/60K	H230*H88	φ200mm

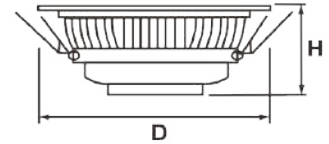

# LED Downlight *DLM Slim*



DLM Slim 4 Inch



DLM Slim 6 Inch



DLM Slim 8 Inch

## Product Specification

Model	: Certaflux DLM Slim
Lamp	: CertaFlux DLM Slim PHILIPS
Housing	: Die Casting Aluminium
Ingress Protection	: IP 20

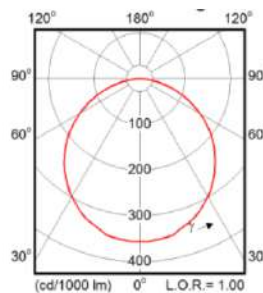

## Dimension (mm)

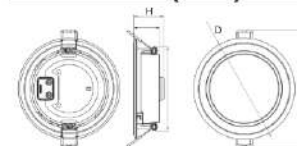

Type	D	H
DLM Slim 4"	120	36
DLM Slim 6"	170	36
DLM Slim 8"	223	37

## Equipment

Lamp	Light Output	Lamp Wattage	System efficacy	Color Temp	CRI	LifeTime	T Case	Drivers
	lm	W	lm/W	K	Ra	hrs	°C	
CertaFlux DLM Slim 600lm 4"	600	6	90	3000 / 4000 / 5000	80	25.000	70	CertaDrive 6W 0.15A 40V LPF I 230V
CertaFlux DLM Slim 1000lm 4"	1000	10	100	3000 / 4000 / 5000	80	25.000	80	CertaDrive 10W 0.25A 40V LPF I 230V
CertaFlux DLM Slim 1000lm 6"	1000	10	100	3000 / 4000 / 5000	80	25.000	70	CertaDrive 10W 0.25A 40V LPF I 230V
CertaFlux DLM Slim 2000lm 6"	2000	20	100	3000 / 4000 / 5000	80	25.000	80	CertaDrive 20W 0.5A 40V LPF I 230V
CertaFlux DLM Slim 2000lm 8"	2000	20	100	3000 / 4000 / 5000	80	25.000	70	CertaDrive 20W 0.5A 40V LPF I 230V

# LED Spot Downlight *FR Series*



FR 2001W



FR 2002W



FR 2003W

## Product Specification

Type : FR 2001W , FR 2002W , FR 2003W  
 Lamp : Master LED  
                   Halogen GU53  
 Material : Die Casting Aluminium  
 Finishing Procces : Powder Coating  
 Ingress Protection : IP 20

## Dimension (mm)

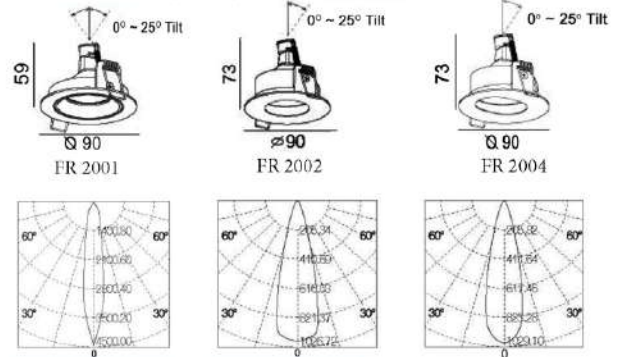

## Equipment

Lamp	Light Output	Lamp Wattage	Module efficacy	Replaced Wattage	Color Temp	CRI	Lfe Time	Degre	Dimmable
	lm	W	lm/W	W	K	Ra	hrs	°	
Master LED	440	7	62	50	2700, 3000, 4000	90	40.000	15, 24, 36	Yes
Master LED	635	8	79	50	2700, 3000	80	40.000	24, 36	No
Master LED	240	4	60	35	2700, 3000	80	25.000	24, 36	No
Master LED	425	5.5	77	50	2700, 3000, 4000	80	25.000	24, 36	No

# LED Spot Downlight *FR Series*



FR 2004W



FR 2005W

## Product Specification

Type : FR 2004W , FR 2005W  
 Lamp : Master LED  
                   Halogen GU53  
 Material : Die Casting Aluminium  
 Finishing Procces : Powder Coating  
 Ingress Protection : IP 20

## Dimension (mm)

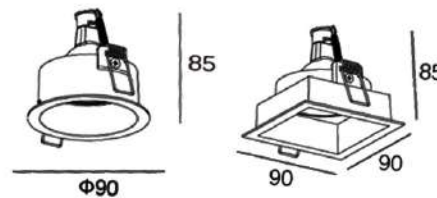

## Equipment

Lamp	Light Output	Lamp Wattage	Module efficacy	Replaced Wattage	Color Temp	CRI	Lfe Time	Degre	Dimmable
	lm	W	lm/W	W	K	Ra	hrs	°	
Master LED	440	7	62	50	2700, 3000, 4000	90	40.000	15, 24, 36	Yes
Master LED	635	8	79	50	2700, 3000	80	40.000	24, 36	No
Master LED	240	4	60	35	2700, 3000	80	25.000	24, 36	No
Master LED	425	5.5	77	50	2700, 3000, 4000	80	25.000	24, 36	No

# LED Spot Downlight *FR Series*



FR 2006W



FR 2009W

## Product Specification

Type : FR 2006W , FR 2009W  
 Lamp : Master LED  
           Halogen GU53  
 Can Use Trafo : ET-E 10 & ET-E 60  
 Material : Die Casting Aluminium  
 Finishing Procces : Powder Coating  
 Ingress Protection : IP 20

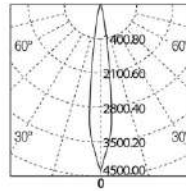

## Dimension (mm)

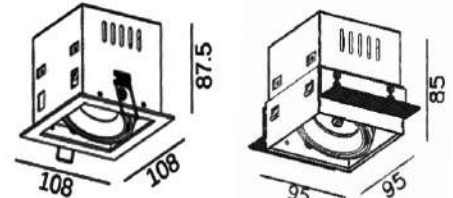

## Equipment

Lamp	Light Output	Lamp Wattage	Module efficacy	Replaced Wattage	Color Temp	CRI	Lfe Time	Degre	Dimmable
	lm	W	lm/W	W	K	Ra	hrs	°	
Master LED	440	7	62	50	2700, 3000, 4000	90	40.000	15, 24, 36	Yes
Master LED	635	8	79	50	2700, 3000	80	40.000	24, 36	No
Master LED	240	4	60	35	2700, 3000	80	25.000	24, 36	No
Master LED	425	5.5	77	50	2700, 3000, 4000	80	25.000	24, 36	No

# LED Spot Downlight *FR Series*



FR 1028 WR/WL



## Product Specification

Type : FR 1028 WR/WL  
 Lamp : Fortimo SLM C PW 1203 I L09 1619 G6  
           Kit Basic core 1500 G1 (COB)  
 Beam Angel : 24° / 38°  
 Material : Die Casting Aluminium  
 Finishing : Powder Coating  
 Ingress Protection : IP 20  
 Diffuser : PMMA Lens (24°) Reflector Cup (38°)  
 Anti-oxidation, anti-corrosion

## Dimension (mm)

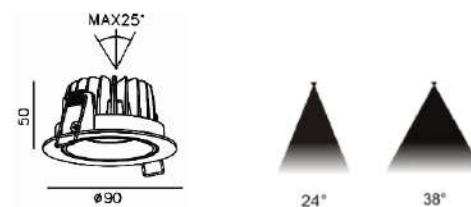

## Equipment

Lamp	Light Output	Lamp Wattage	Module efficacy	Replaced Wattage	Color Temp	CRI	Lfe Time	TCase	Driver
	lm	W	lm/W	W	K	Ra	hrs	°C	
Fortimo SLM C PW 1203 I L09 1619 G6	1100	10	110	50 (Halogen)	3000, 3500, 4000	80, 90	50.000	85	Xitanium 15W 8.35A 42V I 230V
Kit Basic core 1500 G1	1500	13	115	50 (Halogen)	3000, 4000	80	30.000	70	Element LD 15/220-240/350

# LED Spot Downlight *FR Series*



FR 1038 W

## Product Specification

Type	: FR 1038 W
Lamp	: Fortimo SLM C PW 1203 I L09 1619 G6 Kit Basic core 800 G1 (COB)
Beam Angel	: 40°
Material	: Die Casting Aluminium
Finishing Procces	: Powder Coating
Diffuser	: Reflector Cup
Ingress Protection	: IP 20

## Dimension (mm)

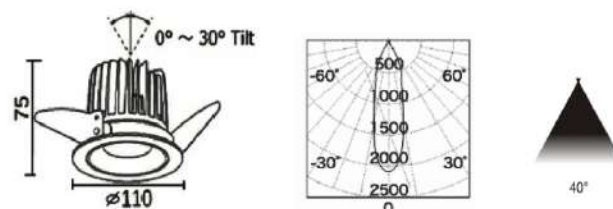

## Equipment

Lamp	Light Output lm	Lamp Wattage W	Module efficacy lm/W	Replaced Wattage W	Color Temp K	CRI Ra	Lfe Time hrs	TCase °C	Driver
Fortimo SLM C PW 1203 I L09 1619 G6	1100	10	110	50 (Halogen)	3000, 3500, 4000	80, 90	50.000	85	Xitanium 15W 8.35A 42V I 230V
Kit Basic core 800 G1	800	8	100	50 (Halogen)	3000, 4000	80	30.000	70	Element LD 8/220-240/180

# LED Spot Downlight *FR Series*



FR 1029 WL



FR 1030 WL

## Product Specification

Type	: FR 1029 , FR 1030
Lamp	: Fortimo SLM C PW 1203 I L09 1619 G6 Kit Basic core 1500 G1 (COB)
Beam Angel	: 24°
Material	: Die Casting Aluminium
Finishing Procces	: Powder Coating
Diffuser	: PMMA Lens (24°)
Ingress Protection	: IP 20

## Dimension (mm)

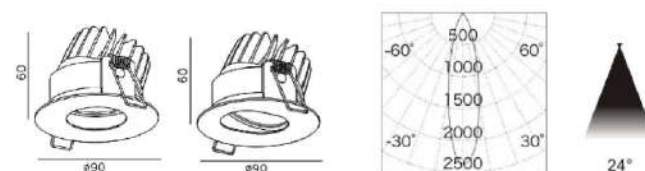

## Equipment

Lamp	Light Output lm	Lamp Wattage W	Module efficacy lm/W	Replaced Wattage W	Color Temp K	CRI Ra	Lfe Time hrs	TCase °C	Driver
Fortimo SLM C PW 1203 I L09 1619 G6	1100	10	110	50 (Halogen)	3000, 3500, 4000	80, 90	50.000	85	Xitanium 15W 8.35A 42V I 230V
Kit Basic core 1500 G1	1500	13	115	50 (Halogen)	3000, 4000	80	30.000	70	Element LD 15/220-240/350

# LED Spot Downlight *FR Series*

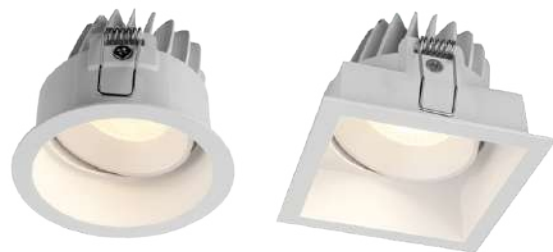

FR 1031W-R

FR 1032W-L

## Product Specification

- Type : FR 1031W-R , FR 1032W-L
- Lamp : Fortimo SLM C PW 1203 I L09 1619 G6  
Kit Basic core 1500 G1 (COB)
- Beam Angel : 24° , 25°
- Material : Die Casting Aluminium
- Finishing Procces : Powder Coating
- Diffuse : PMMA Lens (24°)  
Reflector Cup (25°)
- Ingress Protection : IP 20

## Dimension (mm)

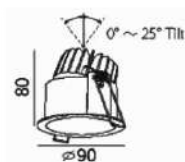

FR 1031W-R

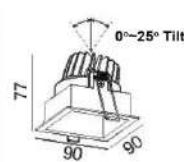

FR 1032W-L

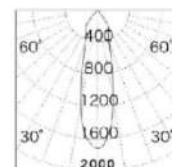

24° 25°

## Equipment

Type	Light Output	Lamp Wattage	Module efficacy	Replaced Wattage	Color Temp	CRI	Lfe Time	TCase	Driver
	lm	W	lm/W	W	K	Ra	hrs	°C	
Fortimo SLM C PW 1203 I L09 1619 G6	1100	10	110	50 (Halogen)	3000, 3500, 4000	80, 90	50.000	85	Xitanium 15W 8.35A 42V I 230V
Kit Basic core 1500 G1	1500	13	115	50 (Halogen)	3000, 4000	80	30.000	70	Element LD 15/220-240/350

# LED Spot Downlight *FR Series*



FR 1004 W

FR 1035 W

## Product Specification

- Type : FR 1004W , FR 1035W
- Lamp : Fortimo SLM C PW 1203 I L09 1619 G6  
Kit Basic core 1500 G1 (COB)
- Beam Angel : 30°
- Material : Die Casting Aluminium
- Finishing Procces : Powder Coating
- Diffuser : Reflector Cup
- Ingress Protection : IP 20

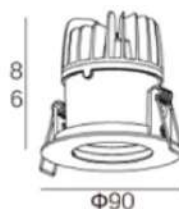

FR 1004 W



FR 1035 W

## Equipment

Type	Light Output	Lamp Wattage	Module efficacy	Replaced Wattage	Color Temp	CRI	Lfe Time	TCase	Driver
	lm	W	lm/W	W	K	Ra	hrs	°C	
Fortimo SLM C PW 1203 I L09 1619 G6	1100	10	110	50 (Halogen)	3000, 3500, 4000	80, 90	50.000	85	Xitanium 15W 8.35A 42V I 230V
Kit Basic core 1500 G1	1500	13	115	50 (Halogen)	3000, 4000	80	30.000	70	Element LD 15/220-240/350

# LED Spot Downlight *FR Series*



FR 1039 W & FR 1040 W

## Product Specification

Type	: FR 1039 W & FR 1040 W
Lamp	: Fortimo SLM C PW 1203 I L09 1619 G6 Kit Basic core 1500 G1 (COB)
Beam Angel	: 25°
Material	: Die Casting Aluminium
Finishing Procces	: Powder Coating
Diffuser	: Reflector Cup
Ingress Protection	: IP 20

## Dimension (mm)

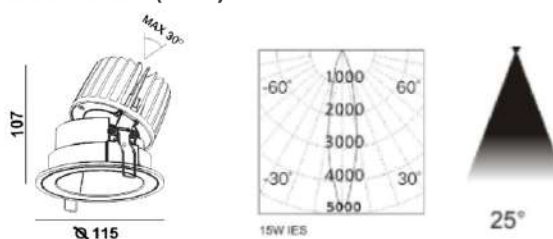

## Equipment

Lamp	Light Output lm	Lamp Wattage W	Module efficacy lm/W	Replaced Wattage W	Color Temp K	CRI Ra	Lfe Time hrs	TCase °C	Driver
Fortimo SLM C PW 1203 I L09 1619 G6	1100	10	110	50 (Halogen)	3000, 3500, 4000	80, 90	50.000	85	Xitanium 15W 8.35A 42V I 230V
Kit Basic core 1500 G1	1500	13	115	50 (Halogen)	3000, 4000	80	30.000	70	Element LD 15/220-240/350

# LED Spot Downlight *L Series*



L10080T

L10100T

L10125T

## Light Distribution Curve

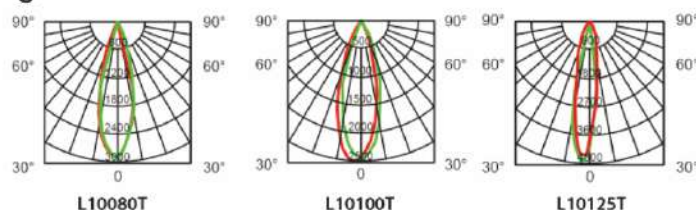

## Product Specification

Type	: L10080T , L10100T , L10125T
Lamp	: Fortimo SLM C PW 1203 I L09 1619 G6 Kit Basic core 800 G1 (COB)
Beam Angel	: 15° & 30°
Material	: Die Cast Aluminium
Finishing Procces	: Powder Coating
Ingress Protection	: IP 20

## Dimension (mm)



Type	D	H	Cut Hole
L 10080 T	75	100	80
L 10100 T	83.4	106	89
L 10125 T	106	112	112

## Equipment

Lamp	Light Output lm	Lamp Wattage W	Module efficacy lm/W	Replaced Wattage W	Color Temp K	CRI Ra	Lfe Time hrs	TCase °C	Driver
Fortimo SLM C PW 1203 I L09 1619 G6	1100	10	110	50 (Halogen)	3000, 3500, 4000	80, 90	50.000	85	Xitanium 15W 8.35A 42V I 230V
Kit Basic core 800 G1	800	8	100	50 (Halogen)	3000, 4000	80	30.000	70	Element LD 8/220-240/180



# LED Spot Downlight *FR Series*

## Product Specification



FR 1041 W

FR 1042 W

Type : FR 1041 W , FR 1042 W  
 Lamp : Fortimo SLM C PW 1205 I L13 2024 G6  
 Fortimo SLM C PW 1208 I L15 2024 G6  
 Kit Basic core 2000 G1 (COB)  
 Kit Basic core 3000 G1 (COB)  
 Beam Angel : 24° , 45°  
 Material : Die Cast Aluminium  
 Finishing Procces : Powder Coating  
 Ingress Protection : IP 20

## Dimension (mm)

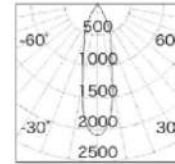
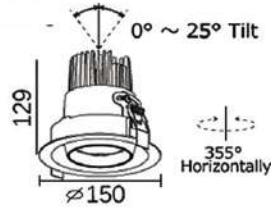

## Equipment

Lamp	Light Output	Lamp Wattage	Module efficacy	Replaced Wattage	Color Temp	CRI	Lfe Time	TCase	Driver
	lm	W	lm/W	W	K	Ra	hrs	°C	
Fortimo SLM C PW 1205 I L13 2024 G6	2000	17	117	35	3000, 3500, 4000	80, 90	50.000	85	Xitanium 21W 0.5A 42V I 230V CertaDrive 20W 0.5A 40V I 230 Element LD 20/220-240/500
Kit Basic core 2000 G1	2000	21	95	35	3000, 4000	80, 90	30.000	70	
Fortimo SLM C PW 1208 I L15 2024 G6	3000	27.5	117	50	3000, 3500, 4000	80, 90	50.000	85	
Kit Basic core 3000 G1	3000	28	107	50	3000, 4000	80, 90	30.000	70	Xitanium 32W 0.7/0.75A 42V I 230V CertaDrive 30W 0.7A 42V 230V Element LD 30/220-240 700

# LED Spot Downlight *FR Series*



FR 1043 W & FR 1044 W

## Product Specification

Type : FR 1043 W , FR 1044 W  
 Lamp : Fortimo SLM C PW 1208 I L15 2024 G6  
 Kit Basic core 3000 G1 (COB)  
 Beam Angel : 15°  
 Material : Die Casting Aluminium  
 Finishing Procces : Powder Coating  
 Diffuser : Reflector Cup  
 Ingress Protection : IP 20

## Dimension (mm)

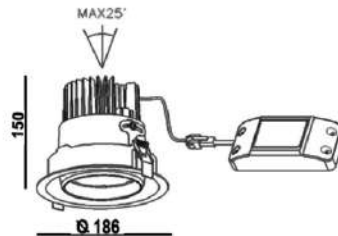
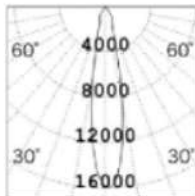

Type	Cut Hole
FR 1043 W	D175
FR 1044 W	D175

## Equipment

Lamp	Light Output	Lamp Wattage	Module efficacy	Replaced Wattage	Color Temp	CRI	Lfe Time	TCase	Driver
	lm	W	lm/W	W	K	Ra	hrs	°C	
Fortimo SLM C PW 1208 I L15 2024 G6	3000	27.5	117	50	3000, 3500, 4000	80, 90	50.000	85	Xitanium 32W 0.7/0.75A 42V I 230V CertaDrive 30W 0.7A 42V 230V Element LD 30/220-240 700
Kit Basic core 3000 G1	3000	28	107	50	3000, 4000	80, 90	30.000	70	

# LED Spot Downlight *L Series*



**L10150**  
(can adjustable)

**L10155**

**L10156**

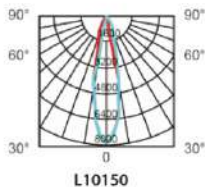

L10150

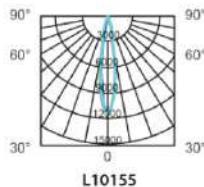

L10155

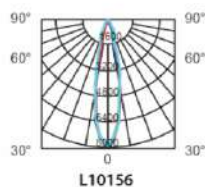

L10156

## Product Specification

Type	: L10150 , L10155 , L10156
Lamp	: Fortimo SLM C PW 1208   L15 2024 G6 Kit Basic core 3000 G1 (COB)
Beam Angel	: 24° / 36°
Material	: Die Cast Aluminium
Finishing Procces	: Powder Coating
Colour	: Sand White
Ingress Protection	: IP 20

## Dimension (mm)

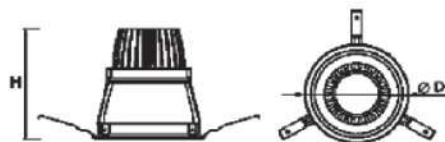

Type	D	H	Cut Hole
L 10150	155	105	143
L 10155	155	161	143
L 10156	155	131.5	143

## Equipment

Lamp	Light Output	Lamp Wattage	Module efficacy	Replaced Wattage	Color Temp	CRI	Lfe Time	TCase	Driver
	lm	W	lm/W	W	K	Ra	hrs	°C	
Fortimo SLM C PW 1208   L15 2024 G6	3000	27.5	117	50	3000, 3500, 4000	80, 90	50.000	85	Xitanium 32W 0.7/0.75A 42V   230V CertaDrive 30W 0.7A 42V 230V Element LD 30/220-240 700
Kit Basic core 3000 G1	3000	28	107	50	3000, 4000	80, 90	30.000	70	

# LED Spot Downlight *PH Series*



**PH 11080**

**PH 11108**  
(with Lens)

## Product Specification

Type	: PH 11080 , PH 11108
Lamp	: Fortimo SLM C PW 1205   L13 2024 G6 Fortimo SLM C PW 1208   L15 2024 G6 Kit Basic core 2000 G1 (COB) Kit Basic core 3000 G1 (COB)
Beam Angel	: 24°
Material	: Die Casting Aluminium
Finishing Procces	: Powder Coating
Ingress Protection	: IP 20
Diffuser	: Reflector Cube
Driver to ensure long lifetime and high performance	

## Dimension (mm)

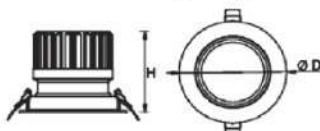

Type	D	H	Cut Hole
PH 11080	122	108	110

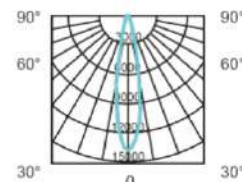

## Equipment

Lamp	Light Output	Lamp Wattage	Module efficacy	Replaced Wattage	Color Temp	CRI	Lfe Time	TCase	Driver
	lm	W	lm/W	W	K	Ra	hrs	°C	
Fortimo SLM C PW 1205   L13 2024 G6	2000	17	117	35	3000, 3500, 4000	80, 90	50.000	85	Xitanium 21W 0.5A 42V   230V CertaDrive 20W 0.5A 40V   230 Element LD 20/220-240/500
Kit Basic core 2000 G1	2000	21	95	35	3000, 4000	80, 90	30.000	70	
Fortimo SLM C PW 1208   L15 2024 G6	3000	27.5	117	50	3000, 3500, 4000	80, 90	50.000	85	Xitanium 32W 0.7/0.75A 42V   230V CertaDrive 30W 0.7A 42V 230V Element LD 30/220-240 700
Kit Basic core 3000 G1	3000	28	107	50	3000, 4000	80, 90	30.000	70	

# LED Spot Downlight *FR Series*



FR 1055 B-L

## Product Specification

Type : FR 1055 B-L  
 Lamp : Fortimo SLM C PW 1203 I L09 1619 G6  
 Kit Basic core 1500 G1 (COB)  
 Beam Angel : 24° / 36°  
 Material : Die Casting Aluminium  
 Finishing Procces : Powder Coating

## Dimension (mm)

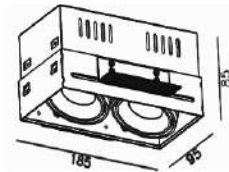

Type Cut Hole  
 FR 1055 B-L 183 x 96

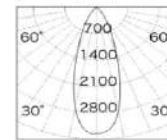
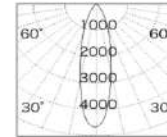

## Equipment

Lamp	Light Output	Lamp Wattage	Module efficacy	Replaced Wattage	Color Temp	CRI	Lfe Time	TCase	Driver
	lm	W	lm/W	W	K	Ra	hrs	°C	
Fortimo SLM C PW 1203 I L09 1619 G6	1100	10	110	50 (Halogen)	3000, 3500, 4000	80, 90	50.000	85	Xtitanium 15W 8.35A 42V I 230V
Kit Basic core 1500 G1	1500	13	115	50 (Halogen)	3000, 4000	80	30.000	70	Element LD 15/220-240/350

# LED Spot Downlight *L Series*



L21001



L21002

## Product Specification

Type : L21001 , L21002  
 Lamp : Fortimo SLM C PW 1208 I L15 2024 G6  
 Kit Basic core 3000 G1 (COB)  
 Beam Angel : 24° / 36°  
 Material : Die Cast Aluminium  
 Finishing Procces : Powder Coating  
 Colour : Sand White, Sand Black  
 Ingress Protection : IP 20

## Dimension (mm)

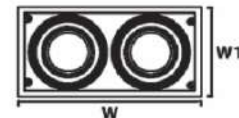
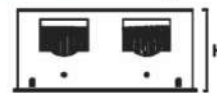

Type	W	W1	H	Cut Hole
L 21001	146	146	133	L138 x W138
L 21002	288	146	133	L278 x W138

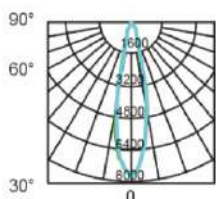

L21001

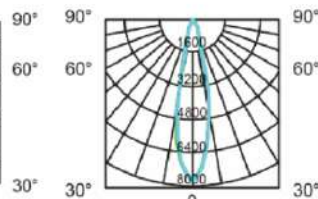

L21002

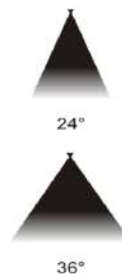

## Equipment

Lamp	Light Output	Lamp Wattage	Module efficacy	Replaced Wattage	Color Temp	CRI	Lfe Time	TCase	Driver
	lm	W	lm/W	W	K	Ra	hrs	°C	
Fortimo SLM C PW 1208 I L15 2024 G6	3000	27.5	117	50	3000, 3500, 4000	80, 90	50.000	85	Xtitanium 32W 0.7/0.75A 42V I 230V
Kit Basic core 3000 G1	3000	28	107	50	3000, 4000	80, 90	30.000	70	CertaDrive 30W 0.7A 42V 230V Element LD 30/220-240 700

# LED Spot Downlight *RS Series*

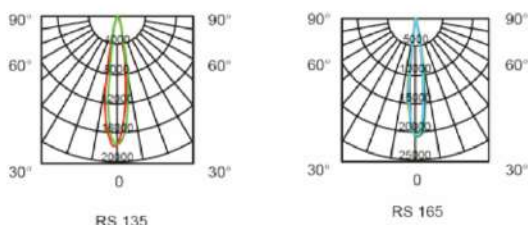

## Product Specification

Type	: RS 135 , RS 165
Lamp	: Fortimo SLM C PW 1208 I L15 2024 G6 Kit Basic core 3000 G1 (COB)
Beam Angel	: 15°
Material	: Die Cast Aluminium
Finishing Procces	: Powder Coating
Ingress Protection	: IP 20

## Dimension (mm)

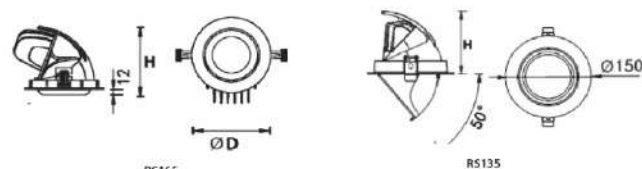

Type	D	H	Cut Hole
RS 135	101	116	140
RS 165	166	151	150

## Equipment

Lamp	Light Output	Lamp Wattage	Module efficacy	Replaced Wattage	Color Temp	CRI	Lfe Time	TCase	Driver
	lm	W	lm/W	W	K	Ra	hrs	°C	
Fortimo SLM C PW 1208 I L15 2024 G6	3000	27.5	117	50	3000, 3500, 4000	80, 90	50.000	85	Xitanium 32W 0.7/0.75A 42V I 230V CertaDrive 30W 0.7A 42V 230V Element LD 30/220-240 700
Kit Basic core 3000 G1	3000	28	107	50	3000, 4000	80, 90	30.000	70	

# LED Spot Light *L Series*



## Product Specification

Type	: L23920
Lamp	: Fortimo SLM C PW 1205 I L13 2024 G6 Kit Basic core 2000 G1 (COB)
Beam Angel	: 24°
Material	: Die Cast Aluminium
Finishing Procces	: Powder Coating
Ingress Protection	: IP 20

## Dimension (mm)

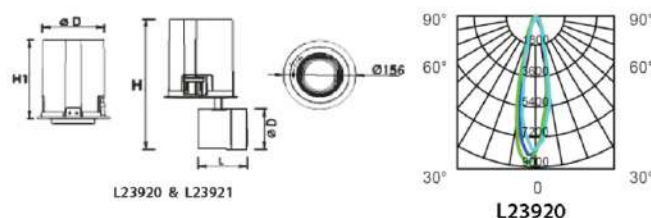

Type	L	D	H	H1	Cut Hole
L 23920	106	92	296	178	146

## Equipment

Lamp	Light Output	Lamp Wattage	Module efficacy	Replaced Wattage	Color Temp	CRI	Lfe Time	TCase	Driver
	lm	W	lm/W	W	K	Ra	hrs	°C	
Fortimo SLM C PW 1205 I L13 2024 G6	2000	17	117	35	3000, 3500, 4000	80, 90	50.000	85	Xitanium 21W 0.5A 42V I 230V CertaDrive 20W 0.5A 40V I 230 Element LD 20/220-240/500
Kit Basic core 2000 G1	2000	21	95	35	3000, 4000	80, 90	30.000	70	

# LED Spot Light *RS Series*



FT 1002 W

## Product Specification

- Type : FT 1002 W
  - Lamp : Fortimo SLM C PW 1203 | L09 1619 G6  
Kit Basic core 1500 G1 (COB)
  - Beam Angel : 25°
  - Material : Die Casting Aluminium
  - Finishing Procces : Powder Coating
  - Ingress Protection : IP 20
  - Diffuser : PMMA Lens + Reflector cup
- Flexible light body structure can be rotatable and adjustable in horizontal and vertical direction.

## Dimension (mm)

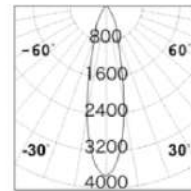

## Equipment

Lamp	Light Output	Lamp Wattage	Module efficacy	Replaced Wattage	Color Temp	CRI	Lfe Time	TCase	Driver
	lm	W	lm/W	W	K	Ra	hrs	°C	
Fortimo SLM C PW 1203   L09 1619 G6	1100	10	110	50 (Halogen)	3000, 3500, 4000	80, 90	50.000	85	Xitanium 15W 8.35A 42V   230V
Kit Basic core 1500 G1	1500	13	115	50 (Halogen)	3000, 4000	80	30.000	70	Element LD 15/220-240/350

# LED Track Light *L Series*



L6120

## Product Specification

- Type : L6120
- Lamp : Fortimo SLM C PW 1208 | L15 2024 G6  
Kit Basic core 3000 G1 (COB)
- Beam Angel : 24°
- Material : Die Cast Aluminium
- Finishing Procces : Powder Coating
- Ingress Protection : IP 20

## Dimension (mm)

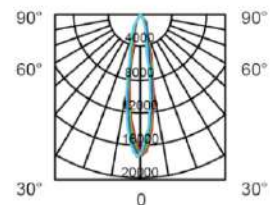
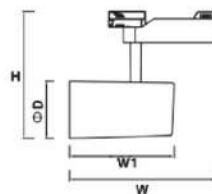

Type	W	W1	D	H
L 6120	293	210	120	267

## Equipment

Lamp	Light Output	Lamp Wattage	Module efficacy	Replaced Wattage	Color Temp	CRI	Lfe Time	TCase	Driver
	lm	W	lm/W	W	K	Ra	hrs	°C	
Fortimo SLM C PW 1208   L15 2024 G6	3000	27.5	117	50	3000, 3500, 4000	80, 90	50.000	85	Xitanium 32W 0.7/0.75A 42V   230V
Kit Basic core 3000 G1	3000	28	107	50	3000, 4000	80, 90	30.000	70	CertaDrive 30W 0.7A 42V 230V Element LD 30/220-240 700

# LED Surface Spot Downlight *FC Series*



FC 2001 W

## Product Specification

Type	: FC 2001 W
Lamp	: Master LED
Beam Angel	: 20° / 30°
Material	: Die Casting Aluminium
Finishing Procces	: Powder Coating
Ingress Protection	: IP 20

## Dimension (mm)

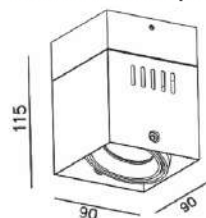

## Equipment

Lamp	Light Output	Lamp Wattage	Module efficacy	Replaced Wattage	Color Temp	CRI	Lfe Time	Degre	Dimmable
	lm	W	lm/W	W	K	Ra	hrs	°	
Master LED	440	7	62	50	2700, 3000, 4000	90	40.000	15, 24, 36	Yes
Master LED	635	8	79	50	2700, 3000	80	40.000	24, 36	No
Master LED	240	4	60	35	2700, 3000	80	25.000	24, 36	No
Master LED	425	5.5	77	50	2700, 3000, 4000	80	25.000	24, 36	No

# Ceiling Light *SK-SR*



Circle



Square

## Product Specification

Lamp	: TL-E 22W/54-765
Housing	: Mild Steel
Finishing	: Powder Coating
Cover	: High Quality Acrylic
Ingress Protection	: IP 20
Can Use Battery	

## Dimension (mm)

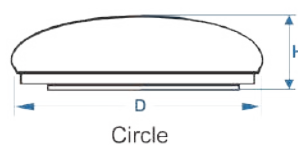

Circle

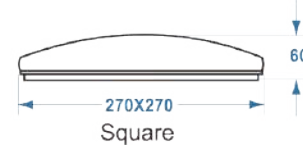

Square

Type	D	H
SK - SR 500	300	75
SK - SR 501	390	98

## Equipment

Lamp	Light Output	Lamp Wattage	System Efficacy	Color Temp	CRI	Life Time
	Lm	W	Lm/W	K	Ra	hrs
TL-E 22W/54-765	1050	22	48	6200	72	13.000

## Exit Lamp *Series*



Wall

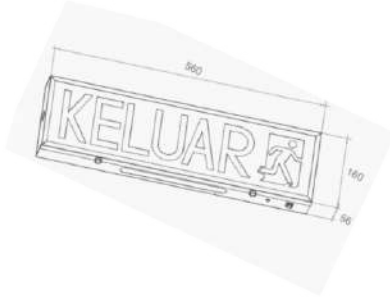

Inbow

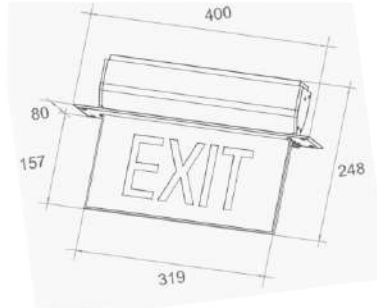

Outbow

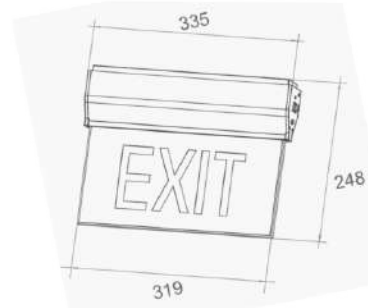

### Product Specification

Die Cast Aluminium End Cap  
 Aluminium Extruded Housing  
 Mild Steel Mounting Base  
 Acrylic Diffuser Panel With Sign  
 Double Sided View (Inbow, Outbow)

Battery : Ni-Cd AA 4.8V 900mAh  
 Emergency Duration Min. 3 Hours  
 Recharge Period 14 - 16 Hours  
 Ingress Protection ( IP 20 )

## Exit Lamp *SAKA Series*



SK-EL-SSW 02



SK-EL-DSH 02



SK-EL-DSH 01

### Product Specification

Lamp : TLD 10 W  
 Housing : Mild Steel  
 Cover : High Quality Acrylic  
 Finishing : Powder Coating  
 Louver : Polycarbonate  
 Ingress Protection : IP 20

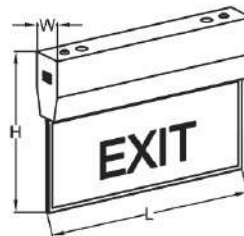

SK - EL - DSH 02

Type	W	L	H
SK - EL - DSH 01	60	396	282
SK - EL - DSH 02	60	396	282

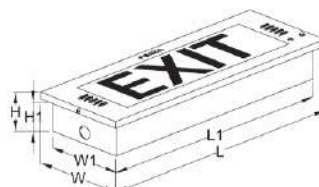

SK - EL - SSW 02

Type	W	W1	L	L1	H	H1
SK - EL - SSW 02	145	122	405	380	59.6	49