



RMI SAKA
PLATINUM

General *Lighting*

RMI SAKA PLATINUM



Product Specification

Lamp : Philips / Osram / Global Led / Free Led
 TL-D 18W - 36W or TL-D 14W - 28W
 TL Led 9W - 18W

Driver : Electronic Ballast / Conventional Ballast

Housing : Rolled Steel (0.7 mm)

Reflector : Aluminium Optic Mirror

Finishing : Powder Coating

Ingress Protection : IP 20

Light Distribution Curve

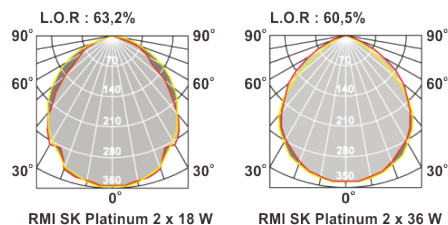

Dimension (mm)

Type T5	W	W1	L	L1	H	H1
PLT 2 x 14 W	250	225	595	570	60	55
PLT 1 x 28 W	125	105	1195	1170	95	85
PLT 2 x 28 W	250	225	1195	1170	60	50

Type T8	W	W1	L	L1	H	H1
PLT 1 x 18 W	125	105	638	615	95	85
PLT 2 x 18 W	250	225	638	615	60	55
PLT 1 x 36 W	125	105	1250	1225	95	85
PLT 2 x 36 W	250	225	1250	1225	60	55

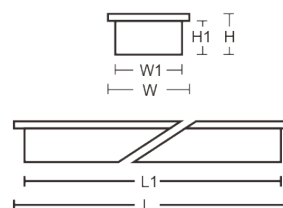

RMI SAKA PREMIUM



SAKA Premium



SAKA Premium Cover

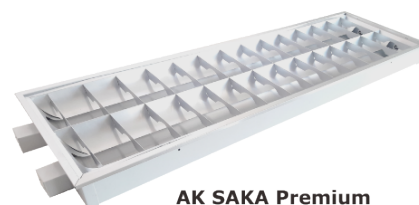

AK SAKA Premium

Product Specification

Lamp : Philips / Osram / Global Led / Free Led
 TL-D 18W - 36W or TL-D 14W - 28W
 TL Led 9W - 18W

Driver : Electronic Ballast / Conventional Ballast

Housing : Rolled Steel (0.4 mm)

Reflector : Aluminium Optic Mirror

Finishing : Powder Coating

Ingress Protection : IP 20

Light Distribution Curve

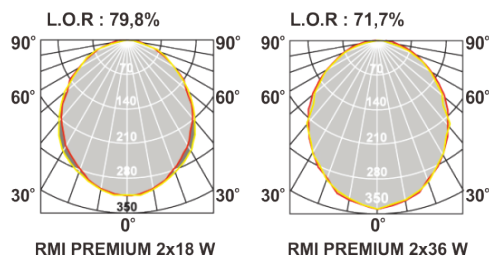

Dimension (mm)

Type T5	W	W1	L	L1	H	H1
PRE 1 X 14 W	227	208	595	570	83	75
PRE 2 X 14 W	320	301	595	570	66	56
PRE 1 X 28 W	227	208	1195	1170	83	75
PRE 2 X 28 W	320	301	1195	1170	66	56

Type T8	W	W1	L	L1	H	H1
PRE 1 X 18 W	227	208	634	613	83	75
PRE 2 X 18 W	320	301	634	613	66	56
PRE 1 X 36 W	227	208	1244	1222	83	75
PRE 2 X 36 W	320	301	1244	1222	66	56

Type T8	W	W1	L	L1	H	H1
AK-PRE 1 X 18 W	230	210	596	576	93	85
AK-PRE 2 X 18 W	296	276	596	576	93	85
AK-PRE 1 X 36 W	230	210	1196	1176	93	85
AK-PRE 2 X 36 W	296	276	1196	1176	93	85

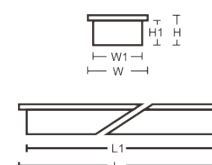

RMI SAKA UL



SAKA UL



SAKA AK UL

Product Specification

- Lamp : Philips / Osram / Global Led / Free Led
TL-D 18W - 36W or TL-D 14W - 28W
TL Led 9W - 18W
- Driver : Electronic Ballast / Conventional Ballast
- Housing : Rolled Steel (0.4 mm)
- Reflector : Aluminium Optic Mirror
- Finishing : Powder Coating
- Ingress Protection : IP 20

Light Distribution Curve

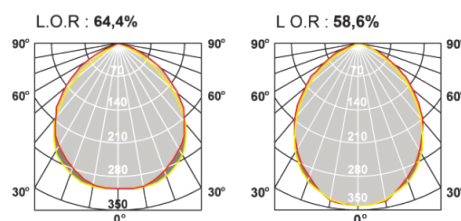

Dimension (mm)

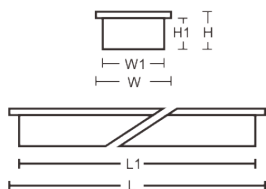

Type T5	W	W1	L	L1	H	H1	Type T8	W	W1	L	L1	H	H1	Type T8	W	W1	L	L1	H	H1
UL 2 X 14 W	295	274	595	570	65	58	UL 2 X 18 W	295	274	634	613	65	58	AK-UL 1 X 18 W	230	210	596	576	93	85
UL 2 X 28 W	295	274	1195	1170	65	58	UL 2 X 36 W	295	274	1244	1222	65	58	AK-UL 2 X 18 W	296	276	596	576	93	85
														AK-UL 1 X 36 W	230	210	1196	1176	93	85
														AK-UL 2 X 36 W	296	276	1196	1176	93	85

RMO SAKA Platinum



Product Specification

- Lamp : Philips / Osram / Global Led / Free Led
TL-D 18W - 36W or TL-D 14W - 28W
TL Led 9W - 18W
- Driver : Electronic Ballast / Conventional Ballast
- Housing : Rolled Steel
- Reflector : Aluminium Optic Mirror
- Finishing : Powder Coating
- Ingress Protection : IP 20
- Available : Saka Platinum, Saka Premium, Saka UL

Dimension (mm)

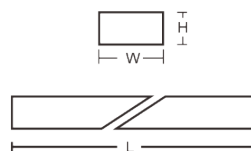

Light Distribution Curve

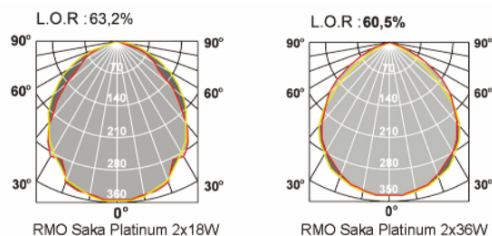

Type T5 RMO-SK-PLT	W	L	H	Type T8 RMO-SK-PLT	W	L	H
2 x 14 W	245	595	60	2 x 18 W	245	635	60
2 x 28 W	245	1195	60	2 x 36 W	245	1245	60

LED Panel *by PHILIPS*

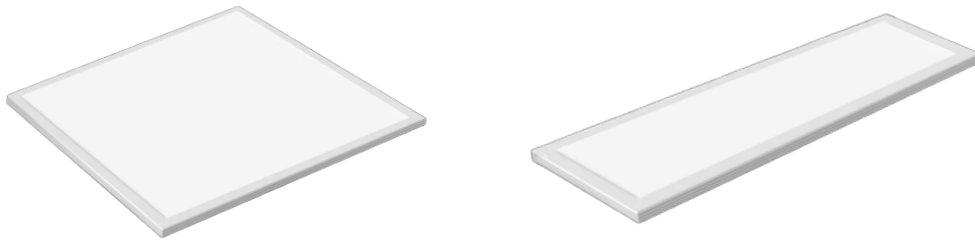

Key features and benefits

- Efficacy up to 100 lm/W on module level
- Ultra-slim LED module
- Excellent light uniformity
- Good color rendering (CRI >80)
- Flexible lumen output due to wide driver choice
- Quick install connector is integrated
- Wide range of dimensions:
60x60; 30x120; 60x120
- Ingress Protection (IP 20)

Light Distribution Curve

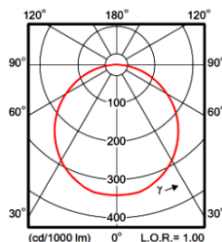

Dimension (mm)

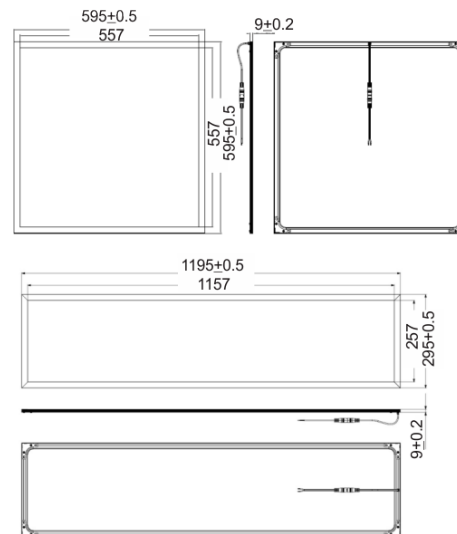

Equipment

Drivers	Light Output (lm)	Lamp Wattage (W)	System efficacy (lm/W)	Color Temp (K)	CRI (Ra)	LifeTime (hrs)
Xitanium 21W 0.5A 42V I 230V	2040	20.9	97.6	3000/4000/6500	80	30.000
Xitanium 32W 0.7/0.75A 42V I 230V	2759	28.7	96.1	3000/4000/6500	80	30.000
Xitanium 32W 0.7/0.75A 42V I 230V	2931	30.8	95.2	3000/4000/6500	80	30.000
Xitanium 44W 1.0A/1.05A 42V I 230V	3905	42.1	92.8	3000/4000/6500	80	30.000
CertaDrive 21W 0.5A 42V I 230V	2040	20.9	97.6	3000/4000/6500	80	30.000
CertaDrive 30W 0.7A 42V I 230V	2759	28.7	96.1	3000/4000/6500	80	30.000
CertaDrive 34W 0.8A 42V I 230V	3100	32.8	94.5	3000/4000/6500	80	30.000
CertaDrive 34W 0.8A 42V I 230V	3905	42.1	92.8	3000/4000/6500	80	30.000

TBIM SAKA



Product Specification

- Lamp : Philips / Osram / Global Led / Free Led
 TL-D 18W - 36W or TL-D 14W - 28W
 TL Led 9W - 18W
- Driver : Electronic Ballast / Conventional Ballast
- Housing : Rolled Steel
- Finishing : Powder Coating
- Cover : Milk or Clear Acrylic
- Ingress Protection : IP 20

Dimension (mm)

TBIM SAKA	W	W1	L	L1	H	H1
1 X 18 W	210	184	641	615	106	100
2 X 18 W	266	240	641	615	106	100
1 X 36 W	210	184	1250	1227	106	100
2 X 36 W	266	240	1250	1227	106	100

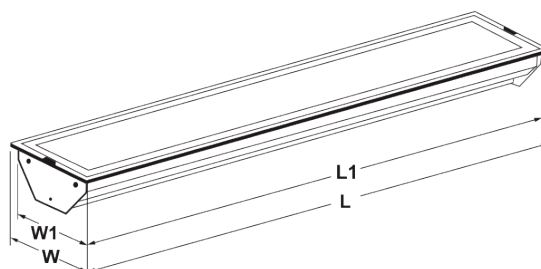

TKIU SAKA



Product Specification

- Lamp : Philips / Osram / Global Led / Free Led
TL-D 18W - 36W or TL-D 14W - 28W
TL Led 9W - 18W
- Driver : Electronic Ballast / Conventional Ballast
- Housing : Rolled Steel
- Reflector : Aluminium Optic Mirror / Powder Coating
- Finishing : Powder Coating
- Protection : IP 20

Dimension (mm)

Type T8	W	W1	L	L1	H	H1
1 X 18 W	210	184	641	615	102	95
2 X 18 W	266	240	641	615	102	95
1 X 36 W	210	184	1250	1224	102	95
2 X 36 W	266	240	1250	1224	102	95

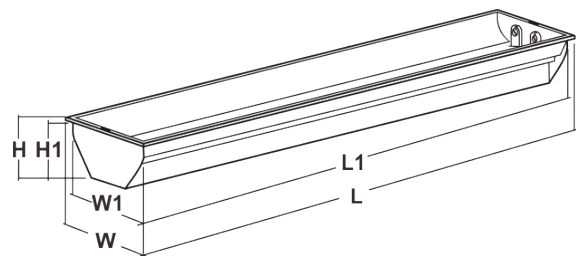

TKOB / TKOU SAKA



TKOB



TKOU

Dimension (mm)

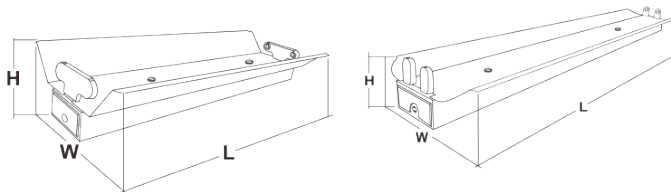

Product Specification

- Lamp : Philips / Osram / Global Led / Free led
TL-D 18W - 36W or TL-D 14W - 28W
TL Led 9W - 18W
- Driver : Electronic Ballast / Conventional Ballast
- Housing : Rolled Steel
- Reflector : Aluminium Optic Mirror / Powder Coating
- Finishing : Powder Coating
- Ingress Protection : IP 20

Type T8 TKOB SAKA	W	L	H	Type T8 TKOU SAKA	W	L	H	Type T5 TKOU SAKA	W	L	H
1 X 18 W	180	615	90	1 X 18 W	165	615	65	1 X 14 W	90	576	40
2 X 18 W	240	615	100	2 X 18 W	200	615	70	2 X 14 W	113	576	40
1 X 36 W	190	1227	100	1 X 36 W	165	1227	70	1 X 28 W	90	1178	40
2 X 36 W	240	1227	100	2 X 36 W	200	1227	70	2 X 28 W	113	1178	40

V-SHAPE SAKA



Product Specification

- Lamp : Philips / Osram / Global Led / Free Led
TL-D 18W - 36W or TL-D 14W - 28W
TL Led 9W - 18W
- Driver : Electronic Ballast / Conventional Ballast
- Housing : Rolled Steel
- Finishing : Powder Coating
- Reflector : Aluminium Optic Mirror / Powder Coating
- Ingress Protection : IP 20

Dimension (mm)

Type T5	W	L	H	Type T8	W	L	H
1 X 14 W	122	576	34	1 X 18 W	183	621	59
2 X 14 W	122	576	34	2 X 18 W	183	621	59
1 X 28 W	122	1178	34	3 X 18 W	183	621	59
2 X 28 W	122	1178	34	1 X 36 W	183	1233	59
				2 X 36 W	183	1233	59
				3 X 36 W	183	1233	59

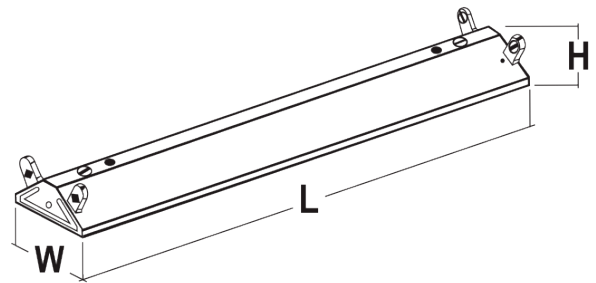

BALK SAKA PREMIUM



Product Specification

- Lamp : Philips / Osram / Global Led / Free Led
TL-D 18W - 36W or TL-D 14W - 28W
TL Led 9W - 18W
- Driver : Electronic Ballast / Conventional Ballast
- Housing : Rolled Steel
- Finishing : Powder Coating
- Ingress Protection : IP 20

Dimension (mm)

Type T5	W	L	H	Type T8	W	L	H
1 X 14 W	42	580	28	1 X 18 W	55	622	38
2 X 14 W	42	1180	28	1 X 36 W	55	1231	38
1 X 28 W	66	580	33				
2 X 28 W	66	1180	33				

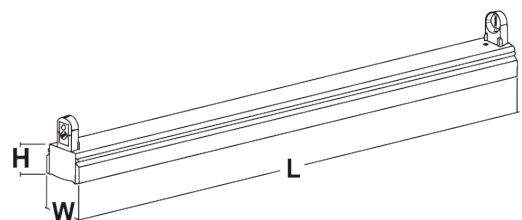

BALK SAKA PRO



Product Specification

- Lamp : Philips / Osram / Global Led / Free Led
 TL-D 18W - 36W or TL-D 14W - 28W
 TL Led 9W - 18W
- Driver : Electronic Ballast / Conventional Ballast
- Housing : Rolled Steel
- Finishing : Powder Coating
- Ingress Protection : IP 20

Dimension (mm)

Type T8	W	L	H
1 X 18 W	52	620	40
1 X 36 W	52	1230	40

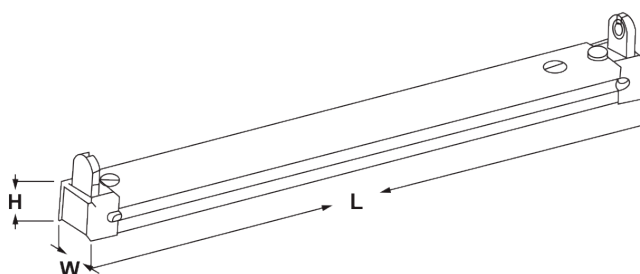

BALK SAKA PRO V3



Product Specification

- Lamp : Philips / Osram / Global Led / Free Led
 TL-D T8: 18W - 36W
 LED Tube T8: 9W - 18W
- Driver : Electronic Ballast / Conventional Ballast
- Housing : Rolled Steel
- Finishing : Powder Coating
- Ingress Protection : IP 20

Dimension (mm)

Type T8	W	L	H
1 X 18 W	41	622	22
2 X 18 W	41	622	22
1 X 36 W	41	1230	22
2 X 36 W	41	1230	22

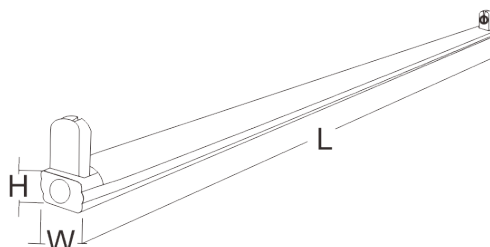

BALK SAKA PREMIUM G2



Product Specification

- Lamp : Philips / Osram / Global Led / Free Led
 TL-D T8: 18W - 36W
 LED Tube T8: 9W - 18W
- Driver : Electronic Ballast / Conventional Ballast
- Housing : Rolled Steel
- Finishing : Powder Coating
- Ingress Protection : IP 20

Dimension (mm)

Type T8	Type Led Tube T8	W	L	H
1 X 18 W	1 X 9 W	35	613	17
1 X 36 W	1 X 18 W	35	1220	17

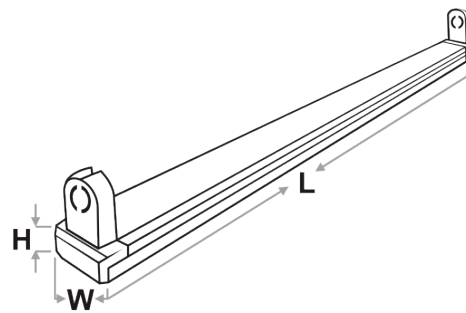

RASON SAKA



Product Specification

- Lamp : Philips / Osram / Global Led / Free Led
 TL-D 18W - 36W or TL Led 9W - 18W
- Driver : Electronic Ballast / Conventional Ballast
- Housing : Rolled Steel
- Finishing : Powder Coating
- Cover : Milk or Clear Acrylic
- Ingress Protection : IP 20

Dimension (mm)

Type	W	L	H
1 X 18 W	130	625	92
2 X 18 W	130	625	92
1 X 36 W	130	1232	92
2 X 36 W	130	1232	92

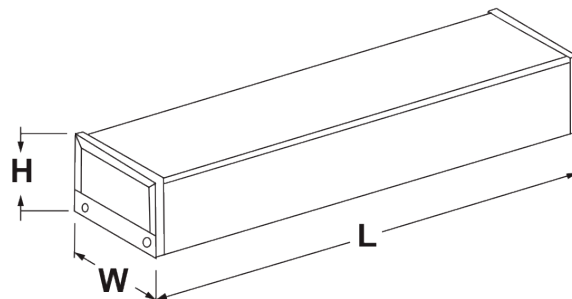

PETROL STATION (SPBU)



Product Specification

- Lamp : Philips / Osram / Global Led
TL-D 28W, TL-D 36W, or TL-D 80W
TL Led 18W
- Gear : Electronic Ballast / Conventional Ballast
- Housing : Cold Rolled Steel
- Reflector : Aluminium Optic Mirror
- Finishing : Powder Coating
- Ingress Protection : IP 20

Dimension (mm)

Type	W	W1	L	L1	H	H1
1 X 28 W	300	250	1220	1170	180	170
1 X 36 W	345	315	1320	1290	180	180
1 X 80 W	370	305	1615	1555	185	170

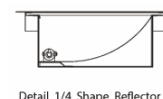
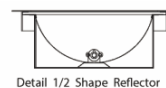
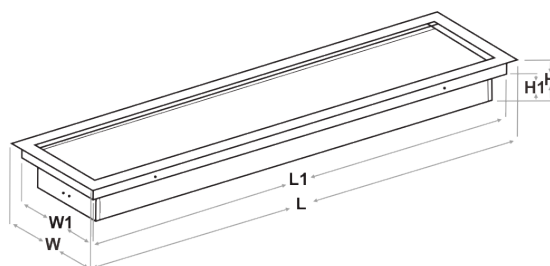

Weatherproof **SAKA**



Product Specification

- Lamp : Philips / Osram / Global Led / Free Led
TL-D 18W - 36W or TL Led 9W - 18W
- Lockdown : Stainless Steel
- Housing : Polycarbonate (PC)
- Cover : Clear Polycarbonate
- Ingress Protection : IP 20

Dimension (mm)

Type TL-D	Type TL-Led	W	L	H
1 X 18 W	1 X 9 W	100	660	110
2 X 18 W	2 X 9 W	150	660	110
1 X 36 W	1 X 18 W	100	1270	110
2 X 36 W	2 X 18 W	150	1270	110

